

# TELEVAC TELEVAC TELEVAC TELEVAC



**MM200**

TELEVAC  
A DIVISION OF THE FREDERICKS COMPANY  
2400 PHILMONT AVE.  
HUNTINGDON VALLEY, PA 19006



**PARTS**

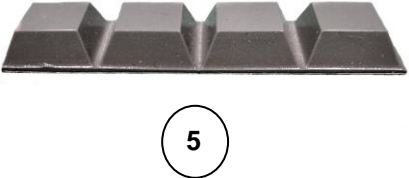

#	QTY	ITEM DESCRIPTION
1	1	MM200
2	1	Instruction Manual
3	1	AC Power Cable
4	1	Power supply module
5	1 SET	Rubber Feet



## TABLE OF CONTENTS

<u>SECTION</u>	<u>TITLE</u>	<u>PAGE</u>
	TABLE OF CONTENTS	1
<b>100</b>	<b>INTRODUCTION</b>	<b>10</b>
101	DESCRIPTION	10
102	STANDARD FEATURES	11
	Measurement Expansion	11
	Sensor interface Modules	11
	Computer Interface Modules	11
	Non-volatile Memory	11
	Display	11
	Keyboard	11
	CPU Configuration	11
103	SETPOINT RELAYS	11
104	VACUUM GAUGE TUBES	11
	Diaphragm	12
	Thermocouple	12
	Convection	12
	Cold Cathode	12
	Hot Cathode	12
	Capacitance Diaphragm Gauge	13
<b>200</b>	<b>INITIAL CHECKOUT</b>	<b>14</b>
201	UNPACKING AND INSPECTION PROCEDURES	14
202	INVENTORY	14
203	INITIAL CHECK PROCEDURES	14
	Correct Operating Voltage	14
	Initial Displays	15



<u>SECTION</u>	<u>TITLE</u>	<u>PAGE</u>
<b>300</b>	<b>INSTALLATION</b>	<b>18</b>
<b>301</b>	<b>MODULE CONFIGURATION</b>	<b>18</b>
<b>302</b>	<b>LINE VOLTAGE SELECTION</b>	<b>23</b>
<b>303</b>	<b>GAUGE CONTROLLER INSTALLATION</b>	<b>23</b>
	Freestanding	23
	Rack Mounted	23
<b>304</b>	<b>GAUGE SENSOR INSTALLATION WARNINGS</b>	<b>24</b>
<b>305</b>	<b>VACUUM CONNECTION FITTINGS</b>	<b>25</b>
	NPT Pipe Thread Connections	25
	O-ring Compression Fittings	25
	Conflat Flange Fittings	25
	KF Flange Connections	26
	Cajon Fittings	26
<b>306</b>	<b>GAUGE SENSOR INSTALLATION</b>	<b>26</b>
<b>307</b>	<b>REMOVAL AND INSTALLATION OF MODULES</b>	<b>27</b>
<b>308</b>	<b>DESCRIPTION OF MODULES</b>	<b>28</b>
	Power Supply Module	28
	Setpoint Relay Module	29
	Communications Module	29
	Thermocouple Module	30
	Convection Module	31
	Diaphragm Module	31
	Cold Cathode Module	32
	3D Hot Cathode Resident Module (I <sup>2</sup> R Degas)	32
	3E Hot Cathode Resident Module (EB Degas)	34
	3F Hot Cathode Mini BA Module (software ver. 2.31 or higher)	35
	Capacitance Diaphragm Modules	38



<u>SECTION</u>	<u>TITLE</u>	<u>PAGE</u>
<b>400</b>	<b>OPERATION</b>	<b>40</b>
<b>401</b>	<b>DISPLAY DESCRIPTION DEFINITIONS</b>	<b>40</b>
	Station Number	40
	Data Display	41
	Units	41
	Gas Type	41
	Leak Rate Indicator	41
	Setpoint Relay Status Indicator	41
<b>402</b>	<b>ERROR INDICATIONS</b>	<b>41</b>
<b>403</b>	<b>KEYPAD DESCRIPTION</b>	<b>42</b>
	<b>PUSHBUTTON</b> Functions	43
	<b>TEST/OP</b> Pushbutton	43
	<b>SETUP</b> Pushbutton	43
	<b>N2/GAS</b> Pushbutton	43
	<b>UP/DOWN</b> Arrows	43
	<b>UNITS</b> Pushbutton	43
	<b>LEAK RT</b> Pushbutton	43
<b>404</b>	<b>RELAY SETPOINTS</b>	<b>43</b>
	Range of Use	44
	Changing Sensor Assignment	44
<b>405</b>	<b>ANALOG 0-10V OUTPUTS</b>	<b>45</b>
	0-10V Outputs	46
	0-10V Output Options	49
<b>406</b>	<b>INITIAL OPERATION SETUP SEQUENCE</b>	<b>50</b>
	Pressure Readings	50
	Relay Setup	50
	Gas	51
	Measurement Units	51
	Leak rate	51
<b>407</b>	<b>3F HOT CATHODE MODULE (Mini BA) (software ver. 2.31 or higher)</b>	<b>52</b>
	Sensitivity	52
	Degas	52
	Filament	52



<u>SECTION</u>	<u>TITLE</u>	<u>PAGE</u>
<b>500</b>	<b>SETUP</b>	<b>53</b>
<b>501</b>	<b>INITIALIZATION</b> Initial Displays	<b>53</b> 53
<b>502</b>	<b>USE OF PUSHBUTTONS</b>	<b>54</b>
	<b>TEST/OP</b> Pushbutton	54
	Return to Normal Operation	54
	Self-Diagnostic Test	54
	<b>UP/DOWN</b> Arrows	56
	<b>SETUP</b> Pushbutton	56
	Cold Cathode Setup	56
	3D & 3E Hot Cathode Setup	59
	Degass Timer	62
	Relay Setpoints	62
	SP#1 – Station Assignment	62
	SP#1 – Setpoint Selection	62
	<b>UNITS</b> Pushbutton	63
	<b>N2/GAS</b> Pushbutton	64
	<b>LEAK RT</b> Pushbutton	64
	<b>HANDLING UNITS</b>	64
<i>For versions 2.31 or higher. Refer to Section 6.2, page 602</i>		
<b>503</b>	<b>3F HOT CATHODE MODULE (Mini-BA)</b>	<b>65</b>
	F (AUTO or SELF or BOTH)	65
	FIL (ON or OFF or RDY)	65
	DGAS (OFF or ON)	65
	DGAS (# time)	65
	FIL NBR (1 or 2)	65
	SENS (# sensitivity)	65



<u>SECTION</u>	<u>TITLE</u>	<u>PAGE</u>
<b>600</b>	<b>COMMUNICATIONS</b>	<b>66</b>
601	RS232 INTERFACING WITH COMPUTER USING MICROSOFT HYPER TERMINAL	66
602	RS232 / RS485 PROTOCOL FOR SOFTWARE VERSIONS 2.31 OR HIGHER	67
	RS232 or RS485	67
	STD or ALT	67
	UNIT #xx	67
	PREF #xx	67
	RS485 Prefix and Addresses Table – For Software Ver. 2.31 or Higher	68
	New Commands For MM200 - For Software Ver. 2.31 or Higher	69
	Commands That Have Been Updated For 3F Modules	69
	Commands For The 3F Hot Cathode MINI-BA Module	70
603	COMMUNICATIONS – FOR SOFTWARE VER. 1.35 – 2.31	70
604	RS232/RS485 COMMANDS	70
	RS232/RS485	70
	Communications	75
	Configuration	77
Output		79
	Display	81
	Gas	82
	Hot Cathode	83
	Leak Rate	84
	Outputs	85
	Set Point Setting Values	88
	Convection Gauge 4A atmosphere Adjustment	92
	Zeroing Thermocouple, Convection, and Diaphragm Gauges	92
	RS232/RS485 Command Summary	95
	RS485 Host Command Set	99
	RS232 Commands Used To Implement RS485	101
	Alternate address Scheme for RS485	102
	Special Commands	102
	RS232 Hardware	103
	RS485 Hardware	103
605	COMMUNICATIONS – FOR SOFTWARE VER. 1.21 – 1.34	104
	RS232 Protocol	104
606	COMMAND SUMMARY – FOR SOFTWARE VER. 1.19 – 1.20	105
	Hardware	108
	Commands	109
	“B” Mode Commands	109
	Cold Cathode	110



<u>SECTION</u>	<u>TITLE</u>	<u>PAGE</u>
<b>606</b>	<b>COMMAND SUMMARY – FOR SOFTWARE VER. 1.19 – 1.20</b>	
	Communications	111
	127 Data Output	113
	Hot Cathode	115
	Leak Rate	116
	Output Formats	117
	Set Points	117
	Set Point Setting Values	118
<b>607</b>	<b>COMMUNICATIONS – FOR SOFTWARE VER. 1.0 – 1.19</b>	<b>119</b>
	RS232 Protocol	119
	RS232 Hardware	127
	Special Commands	127





SECTION	TITLE	PAGE
<b>700</b>	<b>CALIBRATION</b>	<b>128</b>
701	<b>ELECTRICAL "VERIFICATION"</b>	<b>128</b>
	Equipment Required	128
	Procedure	129
702	<b>VACUUM CALIBRATION</b>	<b>129</b>
	Equipment Required	130
	Procedure	131
703	<b>CALIBRATION FOR ALTERNATE GASSES</b>	<b>133</b>
<b>800</b>	<b>SPECIFICATIONS</b>	<b>134.</b>
801	<b>CONTROLLER SPECIFICATIONS</b>	<b>134</b>
802	<b>CONTROLLER DIMENSIONS</b>	<b>134</b>
803	<b>SENSORS</b>	<b>135</b>
804	<b>ORDERING INFORMATION</b>	<b>135</b>
<b>900</b>	<b>TROUBLESHOOTING</b>	<b>137</b>
901	<b>PRELIMINARY TROUBLESHOOTING</b>	<b>137</b>
902	<b>SETUP OF MODULE BOARDS</b>	<b>138</b>
	Setpoint relay module	138
	Digital interface module	140
	Thermocouple module	141
	Convection module	143
	Cold Cathode module	145
	Diaphragm modules	149
	Capacitance Diaphragm module	151
	3D Hot Cathode module	153
	3E Hot Cathode module	154
903	<b>DRAWINGS AND SCHEMATICS</b>	<b>155</b>
904	<b>CLEANING COLD CATHODE GAUGE TUBES</b>	<b>156</b>
905	<b>SUPPRESSOR INSTALLATION FOR NOISY ENVIRONMENTS</b>	<b>157</b>



<u>SECTION</u>	<u>TITLE</u>	<u>PAGE</u>
<b>1000</b>	<b>MISCELLANEOUS</b>	<b>158</b>
	<b>CALIBRATION MODE</b>	<b>158</b>
	<b>DIAPHRAGM GAUGES</b>	<b>158</b>
	<b>INSTALLATION OF EPROMS</b>	<b>159</b>



## 100 INTRODUCTION

This manual provides information pertaining to the installation, operation, and maintenance of the Televac MM 200 vacuum gauge. Various sensor modules, their options, and associated sensors are covered in this manual.



Fig. 1.1 - TELEVAC Modular Gauge

## 101 DESCRIPTION

The TELEVAC MM200 programmable vacuum gauge controller consists of a basic electronic unit and modular sensor signal processing interface boards. These components utilize the latest in digital and analog technology and provide a versatile, easy to use means for measuring pressure (vacuum). With the appropriate system and sensors, pressures ranging from  $10^{-11}$  Torr through  $7.5 \times 10^{+3}$  (10 Bar) are accurately monitored. Additionally, vacuum chamber leak-up rate can be measured. A large selection of sensors and mounting configurations, as well as hardware control interfaces, are available for user convenience.

There is one basic electronics unit, which accepts modules for all gauge types as well as relay modules and digital interface modules. Several sensors are presently available. These are described in Section 104. Other sensor modules will be available in the future. User-installed modules permit expansion. The controller provides a choice of display data formats, display



## 102 STANDARD FEATURES

**MEASUREMENT EXPANSION** - The electronics unit can support additional measurement modules. These additional modules can be any mix of the above listed sensors.

**SENSOR INTERFACE MODULES** - Each gauge has several available sensor interface modules (See Section 300). These modules contain the signal conditioning and measurement circuitry required to operate the sensor properly. They also provide the user with a scalable analog output of pressure.

**COMPUTER INTERFACE MODULES** - The computer interface provides a means for electronic communication with the gauge controller. An RS232 and an RS485 serial data link is provided. The data format is discussed in Section 600.

**NON-VOLATILE MEMORY** - The instrument contains non-volatile memory (EEPROM) that saves all programmable SETUP parameters when the instrument power is off.

**DISPLAY** - The display system for all gauges has two large multiplexed light emitting diode (LED) displays. Each display can show a maximum of four (4) digits of data including an exponent. The display also has smaller displays which indicate selected station number, selected measurement units, alternate gas type, and setpoint relay status.

**KEYPAD** - The keypad is a tactile feel, non-membrane unit that provides keys for programming and control operations. The number of keys has been optimized for simple operation.

**CPU CONFIGURATION** - The central processing unit (CPU) provides the operator choices for the display format, measurement units, communications format and baud rates as well as the ability to lock out keyboard parameter changes.

## 103 SETPOINT RELAYS

The Process Control Relay or Setpoint Relay Module provides four (4) relays per module (eight maximum). These relays are assignable to any installed station.

## 104 VACUUM GAUGE TUBES

This instrument supports several types of vacuum gauge tubes (sensors). Combinations of sensors can be used to cover a wide range of absolute pressures. These sensors can also be used to make measurements in several locations.



## 104 VACUUM GAUGE TUBES (cont.)

**DIAPHRAGM GAUGE** - Measures absolute pressure by detecting very small deflections of a metal diaphragm via a strain gauge. It is not sensitive to gas type. These sensors are temperature compensated, but do respond to rapid changes of temperature. Temperature changes cause zero shifts. Users should note that occasional adjustments of the zero point are normal for sustaining accuracy with this type of sensor, and provision for making this adjustment should be included in the installation. Fine adjustment of the zero and atmospheric point is accomplished at the rear panel on the diaphragm module. Sensor range: 1E: 1 to 800 Torr; 1F: 1000 to 9999 mbar.

**THERMOCOUPLE GAUGE** - Measures absolute pressures by determining the heat loss from a fine wire filament. The response of the sensor depends on the gas type. These sensors are compensated for room temperature variation and are calibrated for vertical operation but operate with little error in any orientation. "Zero" calibration potentiometers are provided for occasional adjustment as required. Sensor range:  $10^{-3}$  to 20 Torr.

**CONVECTION GAUGE** - Measures absolute pressures by determining the heat loss from a fine wire filament. The response of the sensor depends on the gas type. These sensors are compensated for room temperature variation and are calibrated for operation in the **VERTICAL POSITION ONLY**. ZERO and ATM (atmospheric pressure) calibration potentiometers are provided for occasional adjustment as required. Sensor range:  $10^{-3}$  to  $10^{+3}$  Torr.

**COLD CATHODE GAUGE** - A high vacuum sensor that measures pressure by ionizing the residual gases in a magnetron discharge. The body of the gauge serves as the cathode, and is at ground potential. The anode operates at voltages up to 3000 volts. A permanent magnet traps electrons in the gauge to sustain the discharge at very low pressure. This type of gauge may be less precise in its reading than hot cathode gauges and, like the hot cathode gauge, is also sensitive to gas type. However, it is relatively rugged and has no filament to burn out, so that it is often used in applications where hot cathode gauges are not reliable. Cold cathode tubes might experience ignition time delay when trying to turn them on at high vacuum. The 7FCS quick start gauge has a thermo emission igniter inside so every time when power applies to MM200 the filament goes on for 5 second to start ionization chain reaction. There are various designs to cover different pressure (vacuum) ranges. Refer to Table 4.1. Sensor range:  $10^{-11}$  to  $10^{-2}$  Torr.

**HOT CATHODE GAUGE** - Hot cathode gauges typically have the Bayard-Alpert geometry and are used for high vacuum measurements. Both glass enclosed and nude sensors are available. These sensors measure absolute pressures by sensing the ion current generated by the interaction of a beam of electrons from a hot filament with gas molecules in the vacuum system. This kind of gauge is sensitive to gas types. Filaments can be tungsten or Thoria-Coated Iridium. The Iridium filaments don't burn out as readily if accidentally exposed to air when hot, but can be attacked by chlorides and fluorides, which decompose the coating. Tungsten filaments also run noticeably hotter. It is normal for such gauges to have a residual current (the x-ray limit), which may introduce significant errors below  $10^{-10}$  Torr depending on construction. It is also normal for sensors to generate significant amounts of outgassing when the hot filament is turned on. Degassing is often used to accelerate this process prior to making measurements at very low pressures. Sensor range:  $10^{-11}$  to  $10^{-2}$  Torr.

The pressure range for various sensors is shown in Table 4.1.



## 104 VACUUM GAUGE TUBES (cont.)

**CAPACITANCE DIAPHRAGM GAUGE** - Measures absolute pressure by detecting very small deflections of a metal diaphragm via a change in capacitance between the diaphragm and one or more electrodes. It is not sensitive to gas type. These sensors are temperature compensated, but do respond to rapid changes of temperature. Temperature changes cause zero shifts. In some cases the gauges are heated for stability and to prevent condensation of process gasses. Users should note that occasional adjustments of the zero point are normal for sustaining accuracy with this type of sensor, and provision for making this adjustment should be included in the installation. Fine adjustment of the zero and atmospheric point is accomplished at the rear panel on the diaphragm module. Sensor ranges (full scale):

5A = 1000 Torr; 5B = 100 Torr; 5C = 10 Torr  
5D = 1 Torr; 5E = 0.1 Torr; 5F = special

**NOTE:**

Capacitance Diaphragm Gauge Tubes with a range of greater than 1 Torr will **not** control the Cold Cathode automatic turn on!



## 200 INITIAL CHECKOUT

### 201 UNPACKING AND INSPECTION PROCEDURES

1. Remove the Vacuum Gauge Controller from its shipping container
2. Carefully examine the unit for damage that may have occurred during shipping. This is especially important if you notice signs of obvious rough handling on the outside of the cartons. **REPORT ANY DAMAGE TO THE CARRIER AND TO TELEVAC IMMEDIATELY.**
3. DO NOT discard any packing materials until you have taken inventory and completed the check procedures. You may wish retain the packing material for later use.
4. If the instrument must be returned to TELEVAC be sure to contact the service department (215-947-2500) for a Return Material Authorization (RMA) number. Items will not be accepted without an assigned RMA. They must be packaged, insured and shipped with transportation charges prepaid to:

TELEVAC - Division of  
The Fredericks Company  
2400 Philmont Avenue  
Huntingdon Valley, PA 19006

### 202 INVENTORY

Compare the contents of the shipping containers with the invoice to be sure you received all necessary equipment.

### 203 INITIAL CHECK PROCEDURES

For the Initial Check Procedure you need only the control unit and the power cord. Do not connect any sensors, cables or other devices to the unit for this check.

**CORRECT OPERATING VOLTAGE** - Before connecting the power cord, check the line voltage selector, which is part of the power supply board at the rear of the unit. For 100-120V application the arrow should point to the embossed "110" on the switch as shown in Fig. 2.1. To change to 220-240V, use a small screwdriver to turn the switch from its position to align the arrow with the embossed "220" on the switch. (220V not permitted for Capacitance Diaphragm Gauges. Make sure that the power switch is OFF and then plug the power cord into the unit's socket and an appropriate outlet.

It is recommended that a surge protector circuit is used or make sure that your power line is safe from power surge. The noise (power surge) through the power line may alter the contents of a non-volatile memory (known as data memory) in EEPROM and cause the controller to operate erratically.





POSITION #0 #1 #2 #3 #4 #5 #6 #7



**WARNING: Voltages may exist on rear panel connectors.  
 DO NOT touch the exposed connectors when power is connected to the instrument.**

Note that the rear panel configuration shown in Fig. 2.1 is just one of the many possible combinations of gauges and relay modules. This configuration has the following characteristics:

- MM200 - Microprocessor with power supply,  
 4 relays, 5 stations and RS232
- SLOT 0 - Power supply
- SLOT 1 - S1- Setpoint relay module
- SLOT 2 - S1- Setpoint relay module
- SLOT 3 - T1- Dual thermocouple module (2 stations)
- SLOT 4 - C1- Dual convection module (2 stations)
- SLOT 5 - B1- Blank panel
- SLOT 6 - C1- Cold cathode module (1 station)
- SLOT 7 - R1- RS232 /RS485 module

**INITIAL DISPLAYS** - The front panel (shown in Fig. 2.2) is used to observe the displays and to execute the initial self-test of the unit. Remove the protective plastic covering over the displays. Turn the power on by pressing the rear panel power switch to ON. The initial display shows the word "SOFT" followed by a number indicating which software version is present (See Fig. 2.3).





Fig. 2.2 – Front Panel

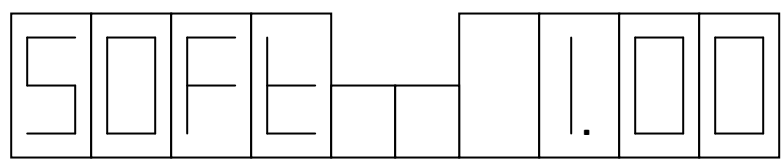

Fig. 2.3 – Software Version



This message is followed by an error code, if any errors are present. (see Section 900). If no errors are present, the initial display for the installed sensor modules appears.

In the initial right-hand display, the default mode is to display the lowest number station installed (except ionization type gauge if there are other than ionization gauges installed). Since no sensor and/or cable is plugged in, the right-hand display reads "CABL" and the adjacent small number reads the corresponding station number (typically #1). The left hand display shows the lowest number ionization (cold cathode or hot cathode) station installed (station #7 in the example shown in Fig. 2.4). Since the high voltage power is off, the display reads "OFF". (See Fig. 2.4). If no ionization gauge is installed, the left-hand display shows the second lowest station installed.

Fig. 2.4 shows the correct initial display for this configuration. If a display does not appear, check the power outlet and the main fuse on the rear of the unit.

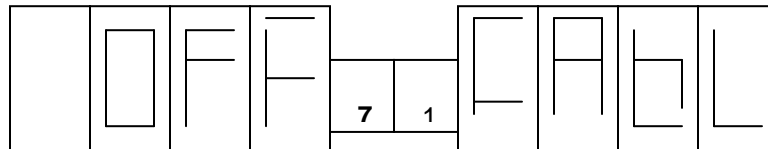

Fig. 2.4 - Typical Initial Display

If further checkout is desired, refer to Section 502.

Assuming that the initial display check is successful, the instrument is ready for installation. Otherwise contact your TELEVAC Service Department (See front cover).



**300 INSTALLATION**

**301 MODULE CONFIGURATION**

A controller is normally ordered with various optional sensor interface modules and they are factory installed before shipment. Before installation, verify that the selection of modules will accomplish the desired results in your application. If additional modules are required or you have any questions about using this gauge in your application, please call Televac at 215-947-2500. If you wish to add modules, refer to Section 307 AND 308.

One possible configuration for this gauge was shown in Section 203. The allowable configurations are restricted by the number of cold cathode and/or hot cathode ionization stations installed.

The MM200 has six slots, which can be populated with various Televac modules. There is also a half slot that can be used to insert a communications module. This is the only slot into which the communications module can be inserted. This board will currently accommodate an RS232/RS485 interface. The other slots can be fitted with various combinations of the following currently available boards:

	PCB #				
TYPE	6200	STA	SLOT	DESCRIPTION	
1E	-220	2	1	A dual diaphragm module.	
1F	-224	2	1	A dual diaphragm module.	
2A	-186	2	1	A dual thermocouple module.	
3D	-226	1	4	A single hot cathode module with Joule de-gassing.	
3E	-232	1	4	A single hot cathode module with EB de-gassing.	
4A	-215	2	1	A dual convection module.	
7B	-227	1	2	A single cold cathode module.	
7E	-223	1	2	A single cold cathode module.	
7F	-245	1	1	A single cold cathode module (7F UHV or 7E as req'd)	
7F	-253	1	1	An interface to the 7ER & 7FR remote modules.	
SP	-211	4	1	A four relay Process Control relay board.	
3F	-290	2	2	A dual Mini BA module	

The 3D and 3E modules occupy four slots each.

The 7B and 7E modules occupy one and a half slots. One of these can be combined with the RS232/RS485 digital interface module so that no space is wasted. In other locations, they will take up two slots.

The 7F module takes up only one slot. It is used with the 7F UHV tube down to 10<sup>-11</sup> Torr or with multiple 7E gauge tubes where space available in the MM200 is limited.

The 7FCS module has a phone jack labeled "starter" at the back panel to plug the igniter cable in.

The 7F 6200-253 module can interface with 7ER & 7FR gauge tubes which have the remote electronics modules.



The maximum number of stations that can be configured is ten. This can be done only if all stations are any mixture of dual modules (e.g., 1E, 1F, 2A, 4A, 5A/B).

**WARNING:**

**If any cold cathode gauge modules are installed, no sensors should be assigned to station number ten (10).**

If there is one relay module installed, then five other slots are available, and still up to ten stations can be installed. With two relay modules, four slots are available, and up to eight stations can be accommodated.

Setpoints must be consecutively numbered starting with number 1 (1 through 4) or number 5 (5 through 8).

**WARNING:**

**All relays must be assigned to a station when first installed, even if they will not be used (any station will suffice).**

Allowable configurations for the MM200 are shown in Table 3.1.



Table 3.1a - Examples of Allowable Configurations for the MM200

MAX # STATIONS	MAX # RELAYS	1	2	3	4	5	6	MAX # STATIONS	MAX # RELAYS
10	8*	A	2X	2X	2X	2X	4S	R	S
		A	2X	2X	2X	2X	CC	R	S
8	8*	A	2X	2X	2X	CC	B L N K	CC	R
		A	2X	CC	B L N K	CC	B L N K	**	R
5	8*	A		HC		2X	CC	R	S
		A				2X	CC	R	S

EPLANATION OF TERMS USED

- 2X = Dual station Thermocouple, Convection, Diaphragm, 7F Cold Cathode or single slot 7E cold cathode
- CC= Single station (two slot) Cold Cathode module (\*\* shared space with RS232)
- 4S = Four setpoint module - \* Can substitute for a 2X module
- RS= RS232 or RS485
- HC = Resident Hot Cathode module



( CONTINUED)

MM200

MAX # STATIONS      MAX # RELAY

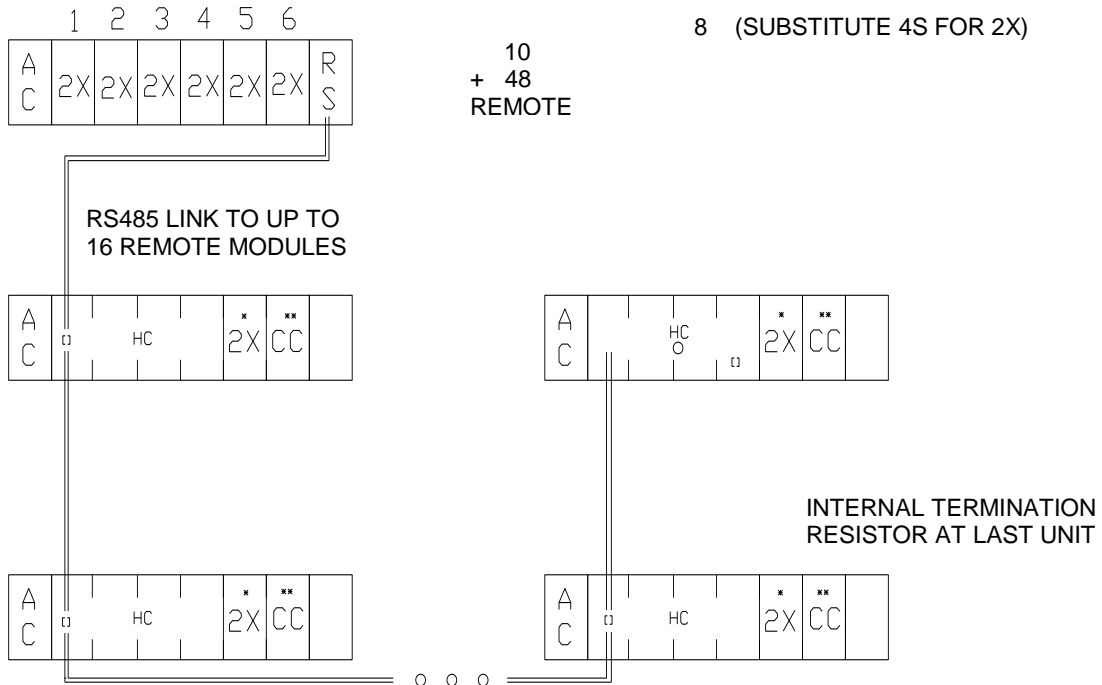

Up to 48 remote sensors consisting of  
 Up to 16 hot cathode remote modules  
 (with no displays) each with up to  
 2 additional sensors in a daisy  
 chain hook up of up to 4000'

\* optional local thermocouple,  
 convection, diaphragm or cold  
 cathode gauges. Maximum is  
 2 additional sensors but only 1  
 cold cathode

REMOTE HOT CATHODE MODULE(S) VIA` MM200

One of several possible combinations using the remote hot cathode module



(CONTINUED)

Table 3.1c – Allowable Configuration for the MM200 (Continued)

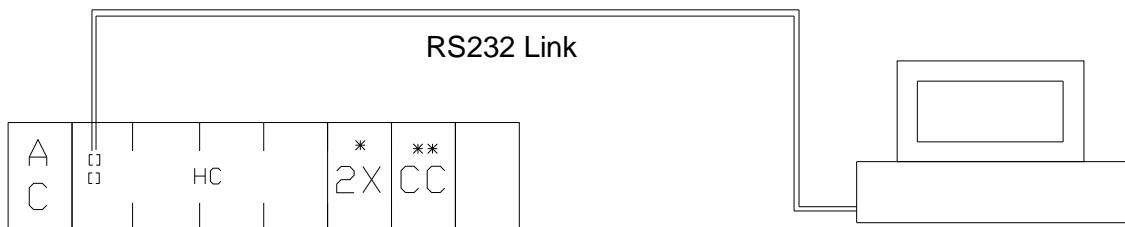

\* Optional thermocouple, diaphragm, convection or cold cathode gauges.  
 Maximum # remote station = 3  
 Including the hot cathode.

Computer

REMOTE HOT CATHODE MODULE(S) VIA COMPUTER



**302 LINE VOLTAGE SELECTION**

The instruments are shipped from the factory with the line voltage set at 110 for 100-120 VAC operation and operates at 50-60 Hz. If 200-240 VAC operation is desired, refer to Section 203 for procedure.

**303 GAUGE CONTROLLER INSTALLATION**

**FREE STANDING**

The instrument can be used as a freestanding unit, panel mounted or mounted in a standard 19" rack.

**RACK MOUNTED** - A rack adapter kit is required to rack mount one or two controllers in a standard 19" rack. Refer to Fig. 3.2 for component configuration.

For one controller, install the small interconnecting adapter to the unit and then the long filler panel to the interconnecting adapter. Use the four (4) screws, nut and washers provided. Alternately use the adapter fillers.

For two controllers, install the two (2) small interconnecting adapters, in front and in back, between the two units.

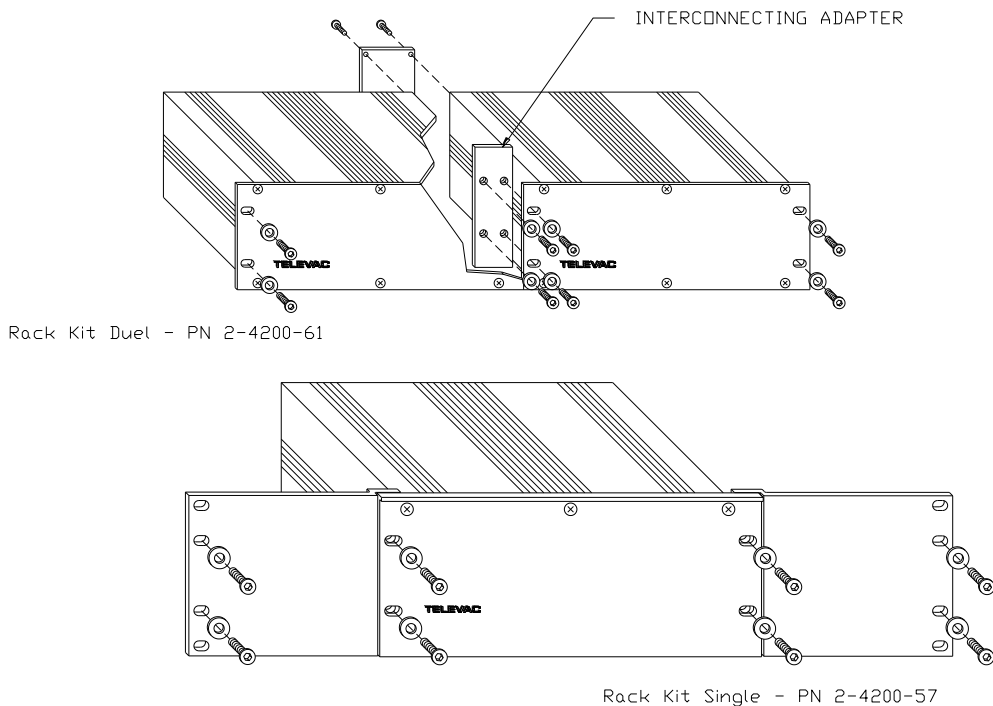

**Fig. 3.2 – Rack Adapter Details**





### 304 GAUGE SENSOR INSTALLATION WARNINGS

- WARNING:** OVERPRESSURE - Do not use quick connects or other friction type connections where positive pressure exists within sensors, such as in backfilling operations.
- WARNING:** SENSOR LOCATION - The gauge sensors should be located as close as possible to the section of the vacuum system where pressure measurement is important. Valves or other constrictions between the sensor and the area where pressure measurement is required may cause erroneous readings or increase the response time.
- WARNING:** CONTAMINATION - Be careful during handling and installation to prevent any loose debris or contamination of any type from entering the gauge sensors. It is good practice to not handle the inside surfaces of any vacuum sensor.
- WARNING:** Implosion and Explosion - Hot Cathode Ionization Gauges  
If handled roughly, glass ionization gauges may implode under vacuum causing flying glass, which may injure personnel. Be sure that cabling to the gauge tube has proper strain relief so that cable tension cannot break the glass. If pressurized above atmospheric pressure, glass tubes may explode, causing dangerous flying glass. A substantial shield should be placed around vacuum glassware to prevent injury to personnel.
- WARNING:** Temperature - Hot Cathode Ionization Gauges  
During degas operations, the envelope of glass ION gauge tubes becomes heated much more than in normal operation. Be sure that materials that are heat sensitive are not in contact with the gauge tube, and be sure that the gauge tube is not located where personnel might come in contact with it.
- CAUTION:** Breakage - Hot Cathode Ionization Gauges  
If the ConFlat flanges are of the rotatable type, check that the flange bolt ring does not drop on the glass tube during installation and cause breakage.



### 305 VACUUM CONNECTION FITTINGS

Six types of vacuum connection fittings are used in the gauge system: NPT, O-ring compression, ConFlat flange, KF, CAJON 8VCR and CAJON 8VCO. (See Table 3.2). A discussion of each is provided below

1. **NPT PIPE THREAD CONNECTIONS** - These connections should be sealed using vacuum sealing compound such as TORR-SEAL, Teflon tape or paste. TORR-SEAL is a trademark of Varian Associates Inc.
2. **O-RING COMPRESSION FITTINGS** - Insert the tubulation of the gauge sensor into the fitting carefully to avoid damage to the O-ring inside the fitting. The connection is then hand-tightened to create a seal. Do not over tighten the connection.

If necessary, a small amount of vacuum grease may be used to obtain a good vacuum seal.

3. **CONFLAT FLANGE FITTINGS** - ConFlat and similar compatible types made by other manufacturers are widely used for attaching devices to ports on high vacuum systems. These flanges utilize knife-edge surfaces and compression of copper gaskets to secure a vacuum seal. Be careful not to damage or contaminate the knife-edges or gaskets during handling operations. (Do not touch copper gasket with hands.) Copper gaskets should be utilized when high temperature or ultra-high vacuum operation is intended. Tighten all flange bolts evenly and fully in a crisscross pattern. Do not use copper gaskets more than once. If the flange is to be baked, pre-lubricate the bolt threads with an antiseize compound (FeIPro R C 100 or equivalent).



**CAUTION: Be careful that the anti-seize compound does not come in contact with the gaskets or the vacuum parts of the flange.**

**4. KF FLANGE CONNECTIONS** - These connections consist of a centering ring and clamp. The centering ring is self-centering and aids in alignment. The clamps should be finger-tightened until both flanges are firmly in contact with the O-ring seal.

Use a new gasket whenever the gauge is reconnected, unless gasket retainer assemblies are used.

**5. CAJON FITTINGS** - If necessary, a small amount of vacuum grease may be used on the O-ring to obtain a good seal.

**306 GAUGE SENSOR INSTALLATION** (Refer to Table 3.3 for Gauge Sensor Installation)

Table 3.3 - Gauge Sensor Installation

TYPE	MOUNTING	GAUGE INLET ORIENTATION
Diaphragm	A	Vertical, down, desired
Convection	A	Vertical, down, required
Thermocouple	A	Vertical, down, desired
Cold Cathode	B	NA
Hot Cathode-glass	C	Horizontal
Hot Cathode-nude	C	NA

A - To prevent debris from entering the gauge sensor and to provide the highest accuracy, it is recommended that the gauge sensor be installed with its main body vertical. Do not mount the sensor in areas where gases are allowed to stream directly into the gauge tube since damage to the filament could result. Install cable to sensor and chassis sockets. Connector is keyed to provide proper orientation at the sensor socket. Do not force connector into socket.

B - The gauge sensor can be mounted in any position. The magnet should not be closer than 1" to any magnetic material. Additionally, when mounting the sensor take into account that the field of the gauge magnet may disturb beams of charged particles in the vacuum system. Install shielded high-voltage BNC connector to gauge and chassis sockets before turning on the power.

C - The gauge sensor can be mounted in any position. It is important that gauge have good communication with the vacuum space for accurate pressure readings, especially at lower pressures.



### 307 REMOVAL AND INSTALLATION OF MODULES

Mounting screws are located at the top and the bottom of each module. To remove a module, remove both screws and pull on the rear panel of the module. If necessary, use a small screwdriver to start the module moving by prying between the module and the enclosure. The module will then slide out easily (See Fig. 3.3).



Fig. 3.3 - Removal / Installation of Modules

To install a module, slide it in place along the track and firmly press it into the mating socket connector. Reinstall screws.

If you wish to add optional modules, install them as outlined below:

**WARNING: TO AVOID POSSIBLE SHOCK, DISCONNECT THE POWER CORD FROM THE CONTROLLER.**



1. Remove the sensor interface module from its packaging. Examine it for shipping damage. If damaged, refer to Section 201.
2. Place jumpers in the desired position to select station numbers, setpoint station assignment, etc. as described in Section 902.
3. Remove the two screws holding the blank cover plate over the module position you plan to use.
4. Align the module with the slots in the instrument and push into place. Press to secure edge connector into the connector on the motherboard.
5. Reinstall the two screws.

### 308 DESCRIPTION OF MODULES

Various types of modules are available for installation in the MM200 gauge. Descriptions of available modules follow as they appear from the rear panel. For detailed descriptions of available modules and their setup, see Section 902.

**POWER SUPPLY MODULE** - The power supply module is located in module slot "0" on the left rear of the instrument. It contains a plug socket for the power cord, a voltage selection switch and an on/off switch. (Fig. 3.4).



Fig. 3.4 - Power Supply Module



**SETPOINT RELAY MODULE** - The rear panel of the setpoint process control relay module is shown in Fig. 3.5. Three (3) terminals are available for each of the four (4) relays. These are NC (Normally Closed), NO (Normally Open) and C (Common).

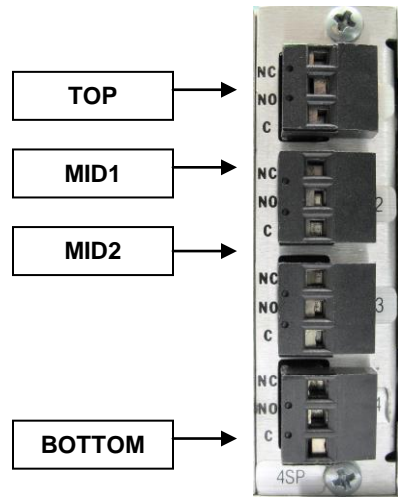

Fig. 3.5 - Rear Panel of the Setpoint Relay Module

**COMMUNICATIONS MODULE** - The rear panel of the module is shown in Fig. 3.6. It features a DE9S (female) connector for the RS232 or RS485 interface cable. A SETUP lock switch is used to permit or to lock out the capability to reset or reassign relays using the SETUP function. Two (2) phone jacks are also shown. The larger one (3.5 mm) is labeled LEAK AUDIO and is used to provide an audible signal whose pitch (frequency) is a function of the instantaneous pressure. The smaller one (2.5 mm) is labeled GAS SW and is used to remotely switch the display to the "alternative gas" (See Section 401). See Figure 9.2 for RS485 termination. An alternate function provided by the smaller phone jack is to accept an enable 24-volt signal that would prevent operation of ion type gauges if not present.



Fig. 3.6 - Rear Panel of the Communications Module



**THERMOCOUPLE MODULE** - The rear panel of the thermocouple module is shown in Fig. 3.7. The gauge tube cables can be connected by inserting the cable connector into the socket and turning the shell clockwise to engage the screw threads for retention of the connector.

The thermocouple module is designed to work with the type 2A thermocouple gauge tube. Special electronics have been added to the 2A thermocouple module to allow the 2A gauge tube to operate up to 20 Torr (20,000 microns).

An analog "0-10V" output (normally 0 to 10VDC) is available at the connector in the center of the panel. This output covers the range of 0 to 1000 microns only in order to give good definition to the data in this lower range. Other outputs are also available. An optional 0 to 10 mVDC is also available (See Section 902). There are three terminals available. The center terminal is a common ground and negative terminal for both the upper and lower thermocouple stations. The upper and lower terminals are the positive signals for the upper and lower stations, respectively.

Between the cable connector and the analog "0-10V" output terminal is a "zero" potentiometer for the thermocouple gauge tube. This potentiometer is used, if required, to adjust the current to the thermocouple sensor "heater", which can be used to compensate, over a limited range, for effects of contamination from the process in the vacuum chamber. The ATM adjust is not used for the thermocouple gauges.

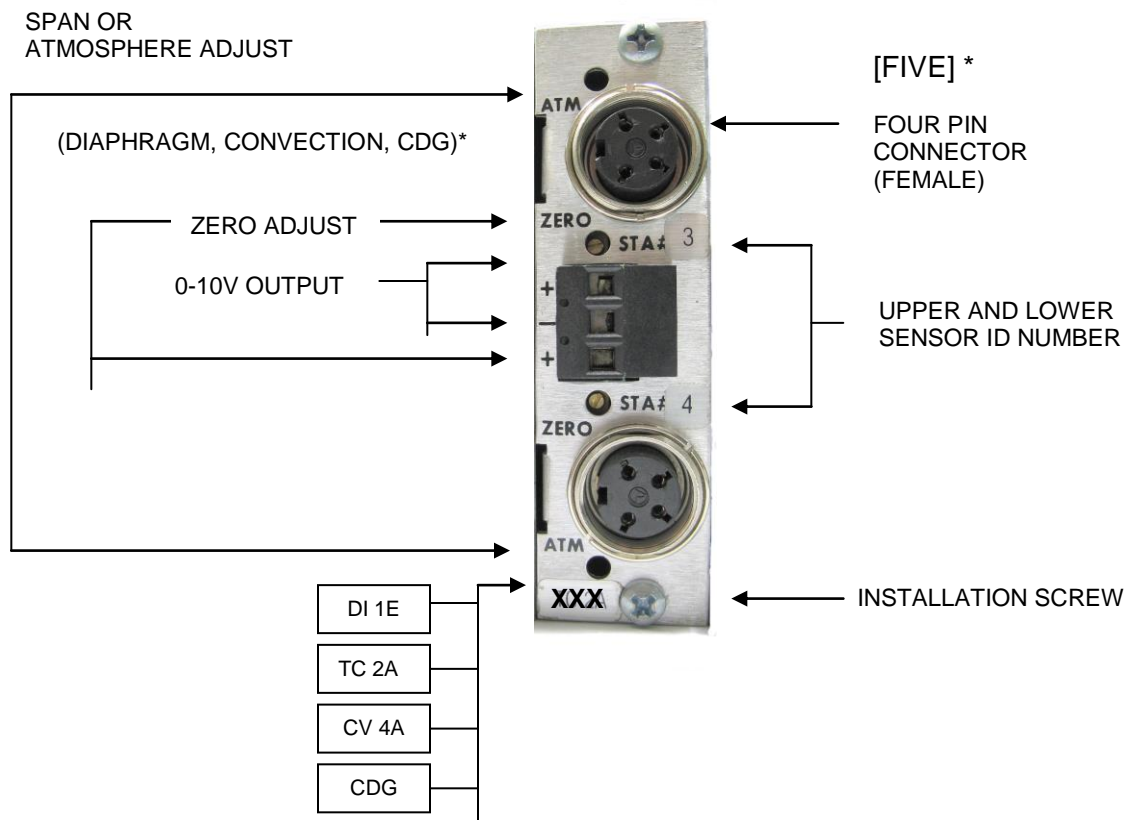

Fig. 3.7 - Rear Panel of the Thermocouple, Convection and Diaphragm Modules



**CONVECTION MODULE** - The rear panel of the convection module is also shown in Fig. 3.7. The only difference that can be seen from the rear panel is the use of the letters CV instead of TC. The gauge tube cables can be connected by inserting the cable connector into the socket and turning the shell clockwise to engage the screw threads for retention of the connector. Note that the convection cable has different wiring and markings from the thermocouple cable.

The convection module is designed to work with the type 4A convection gauge tube. Special electronics have been provided in the 4A convection module to allow it to operate up to above atmospheric pressure (approximately 1000 Torr).

An analog "0-10V " output (normally 0 to 10VDC) is available at the connector in the center of the panel. This output covers the range of  $10^{-3}$  to  $10^{+3}$  Torr. An optional 0 to 10 mvDC is also available (See Section 902). There are three terminals available. The center terminal is a common ground and negative terminal for both the upper and lower convection stations. The upper and lower terminals are the positive signals for the upper and lower stations, respectively.

Between the cable connector and the analog "0-10V " output terminal is a ZERO potentiometer for the convection gauge tube. This potentiometer is used, if required, to adjust the zero at  $1 \times 10^{-5}$  Torr. It can be used to compensate, over a limited range, for effects of contamination from the process in the vacuum chamber. A second potentiometer marked ATM is used to adjust the gauge at atmospheric pressure. This should be set the known value of absolute atmospheric pressure on the gauge - not referred to sea level as is used by the weather bureau or airports.

**DIAPHRAGM MODULES** - The rear panel of the diaphragm modules are also shown in Fig. 3.7. The only difference that can be seen from the rear panel of a thermocouple module is the use of the letters DI instead of TC and the presence of a SPAN potentiometer. The gauge tube cables can be connected by inserting the cable connector into the socket and turning the shell clockwise to engage the screw threads for retention of the connector. Note that the diaphragm cables have different wiring and markings from the thermocouple cable.

The diaphragm modules are designed to work with the type 1E or 1F diaphragm gauge tubes.  
Range 1E: 1 to 1000 Torr; 1F: 1000 to 9999 mbar.

An analog "0-10V " output (normally 0 to 10VDC) is available at the connector in the center of the panel. An optional 0 to 10 mvDC is also available (See Section 902). There are three terminals available. The center terminal is a common ground and negative terminal for both the upper and lower diaphragm stations. The upper and lower terminals are the positive signals for the upper and lower stations, respectively.

Between the cable connector and the analog "0-10V" output terminal is a ZERO potentiometer. This potentiometer is used, if required, to adjust the zero at a pressure two decades below the lower limit of the gauge. It can be used to compensate, over a limited range, for effects of contamination from the process in the vacuum chamber. A second SPAN potentiometer is used to adjust the 1E gauge at atmospheric pressure or the 1F gauge at 10,000 mbar. A known value of absolute atmospheric pressure - not referred to sea level should be used for setting the 1E.





**COLD CATHODE MODULE** - The rear panel of the cold cathode module is shown in Fig. 3.8. The gauge tube cables can be connected by inserting the cable connector into the socket and turning the shell clockwise to engage the lugs for retention of the connector. An analog output (normally 0 to 10VDC) is available at the connector in the center of the panel. There are three terminals available. The lower terminal is a common ground and negative terminal for both the upper two terminals. The upper two terminals are for + 10 volts and + 10 millivolts respectively. Above the analog "0-10V " output terminal is a  $10^{-3}$ , a  $10^{-5}$  or a span adjust potentiometer. These potentiometers are used, if required, for calibration and to compensate, over a limited range, for effects of contamination from the process in the vacuum chamber. There is a phone jack labeled "starter" above the potentiometers for the 7FCS 6200-285 module only. The "ION-ON" potentiometer is not used for the MM200 and its setting is ignored.

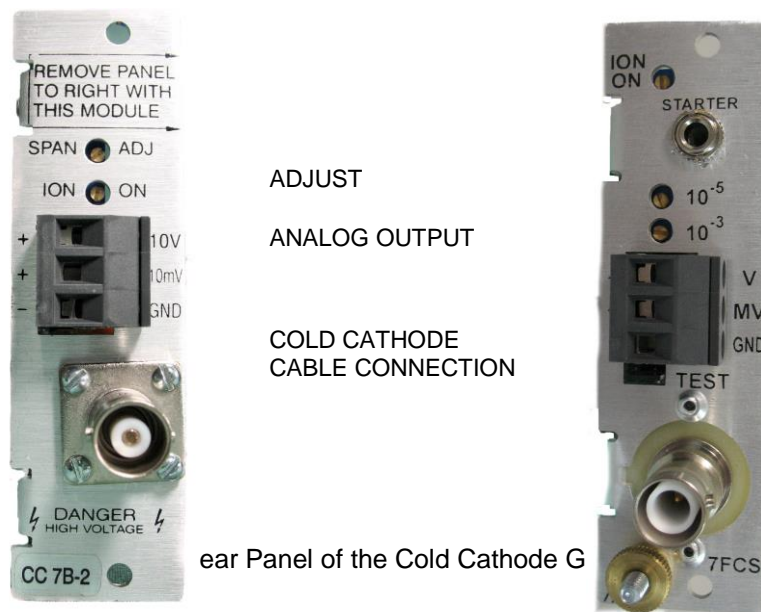

Rear Panel of the Cold Cathode G

**3D HOT CATHODE RESIDENT MODULE (I<sup>2</sup> R DEGAS)** - The rear panel of the 3D hot cathode resident module with resistive (I<sup>2</sup> R) degas is shown in Fig. 3.9. This module occupies 4 module slots. The module must be within 10' (100' with a special cable) of the sensor (gauge tube). No station should be numbered higher than #5.

The sensor power and control cable is connected to the socket in lower right-hand side of the module. Push plug straight in until the connector "clicks" into a locked position. To remove, press on the sides of the connector, until the locks are released, and then pull straight out. The sensor ion collector cable is connected to the module via a BNC connector located in the left-hand middle of the module. Push the mating connector in and twist clockwise to secure. Above the BNC connector is a case ground connection used to connect the unit independently to a "good earth ground". Below the BNC connector is a switch marked TUBE TYPE and above the sensor power cable connector is a sensitivity selector switch. For use see Table 3.4.



Table 3.4 Tube Type

Switch	Rotary Switch	Sensitivity	Sensitivity	Glass Tube	Nude Tube
0	10/12.5	12.5	12.5	Plain	2160-1xx
1	10/12.5	12.5	12.5	Coated	2162-1xx
2	10/12.5	10	10	Plain	2161-2xx I <sup>2</sup> R 2164-352
3	10/12.5	10	10	Coated	2163-2xx
0	20/25	25	25	Plain	EB 2166-452
1	20/25	25	25	Coated	
2	20/25	20	20	Plain	
3	20/25	20	20	Coated	

Note: Switch position with power off or turn power ON/OFF after switching.

There is no filament selector switch for use with dual filament sensors on this unit as this is done through front panel commands. It is necessary to switch the filaments when the filament power is off. It may also be necessary to reverse the cable connector.

An analog output is available at the connector in the lower left of the panel. There are three terminals available. The lower terminal is a common ground and negative terminal for both the upper two terminals. The upper two terminals are for + 10 volts and + 10 millivolts respectively.

Refer to Section 502.3 Hot Cathode Setup for further information.

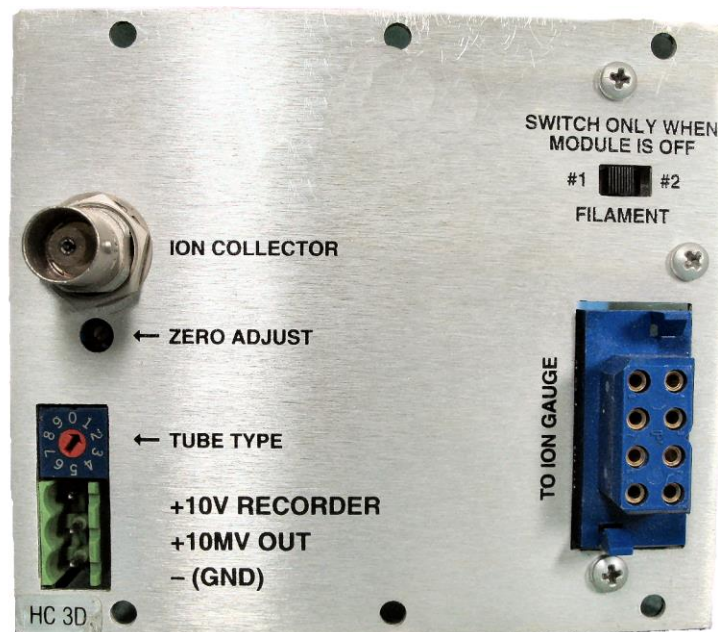

Fig. 3.09 Rear Panel of the Resident 3E Hot Cathode Gauge Module



**3E HOT CATHODE RESIDENT MODULE (EB DEGAS)** - The rear panel of the 3E hot cathode resident module with electron beam (EB) degas is shown in Fig. 3.9. This module occupies 4 module slots. The module must be within 10' (100' with a special cable) of the sensor (gauge tube). No station should be numbered higher than #5.

The sensor power and control cable is connected to the socket in lower right-hand side of the module. Push plug straight in until the connector "clicks" into a locked position. To remove, press on the sides of the connector, until the locks are released, and then pull straight out. The sensor ion collector cable is connected to the module via a BNC connector located in the left-hand middle of the module. Push the mating connector in and twist clockwise to secure.

Above the BNC connector is a case ground connection used to connect the unit independently to a "good earth ground".

Below the BNC connector is a switch marked TUBE TYPE. Switch position with power off or turn power ON/OFF after switching. See Table 3.4.

An analog output is available at the connector in the lower left of the panel. There are three terminals available. The lower terminal is a common ground and negative terminal for both the upper two terminals. The upper two terminals are for + 10 volts and + 10 millivolts respectively.

There is no filament selector switch for use with dual filament sensors on this unit as this is done through front panel commands. It is necessary to switch the filaments when the filament power is off.

Refer to Section 502.3 Hot Cathode SETUP for further information.

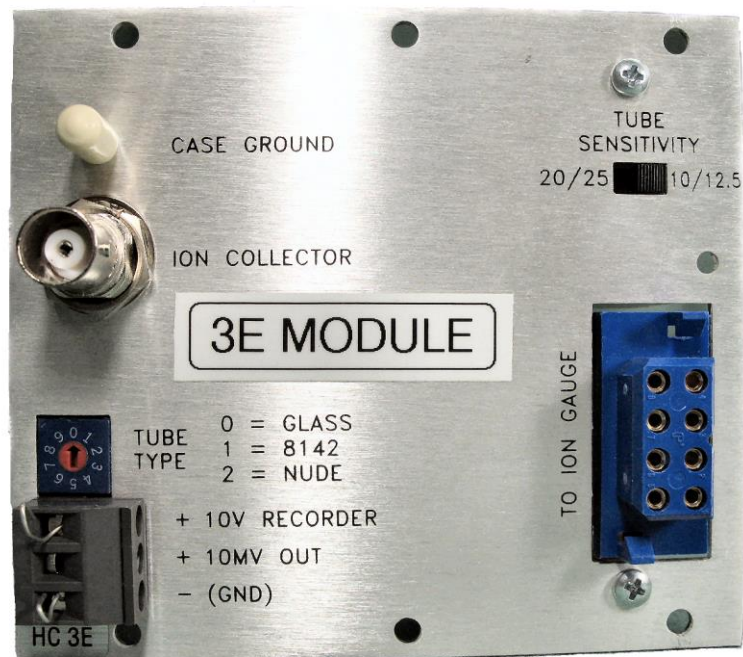
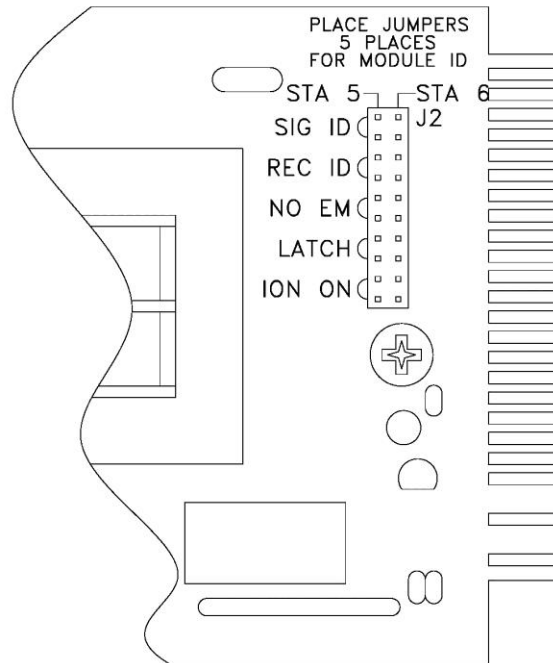

Fig. 3.10 Rear Panel of the Resident 3E Hot Cathode Gauge Module



**3F HOT CATHODE MINI-BA MODULE (Software ver. 2.31 or higher)** - The 3F hot cathode mini-BA module occupies 2 slots inside the mm200 unit. If one module is to be installed, it must be configured to station 5. If a second module is to be installed, it must be configured to station 6.



Place 5 jumpers vertically for station 5. If two 3F hot cathode mini-BA modules are to be used, place 5 jumpers vertically in station 6 for the second module.

When installing the modules into the unit, make sure that the card edge fingers align with the connectors inside the unit. Make sure that the module is properly seated in the connectors then install the 4 screws per module in the back panel.



(Software ver. 2.31 or higher)

The rear panel of the hot cathode mini-BA module is shown below. The gauge tube cables are connected to the ion collector and the 9-pin ion gauge connector. An analog output (normally 0 to 10 VDC) is available at the connector in the upper right as shown below. There are three terminals available. The lower terminal is a common ground and negative terminal for both the upper two terminals. The upper two terminals are for +10 volts and +10 millivolts respectively.

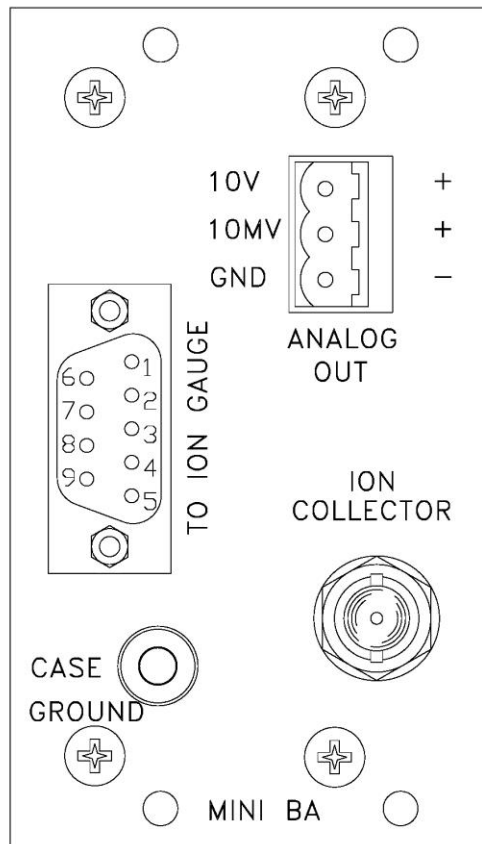

3F hot cathode mini-BA back panel



Software ver. 2.31 or higher)

MINI-BA GAUGE TO 3F MODULE WIRING DIAGRAM

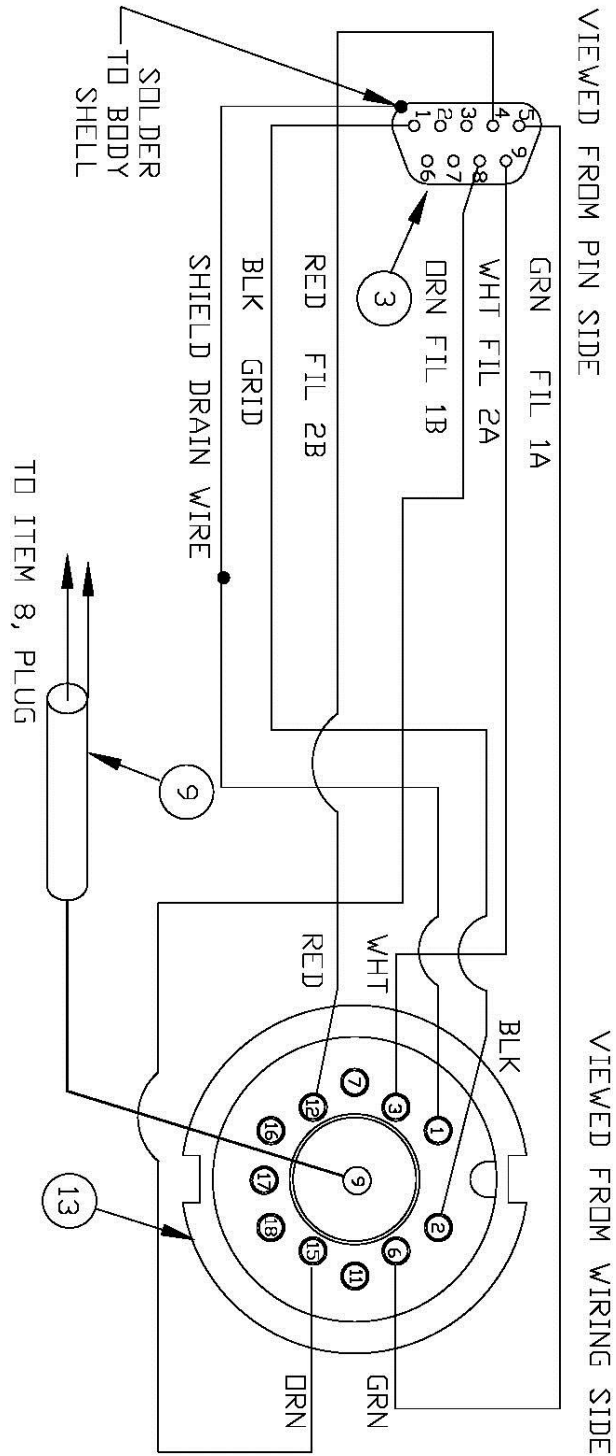





**CAPACITANCE DIAPHRAGM MODULES** - The rear panel of the capacitance diaphragm modules are also shown in Fig. 3.7. The only difference that can be seen from the rear panel of a thermocouple module is the use of the letters CDG instead of TC and the presence of a SPAN potentiometer. The gauge tube cables can be connected by inserting the 5-pin cable connector into the socket and turning the shell clockwise to engage the screw threads for retention of the connector. Note that the capacitance diaphragm cables have different wiring and markings from the thermocouple cable.

The capacitance diaphragm modules are designed to work with the type 5\_\_ capacitance diaphragm gauge tubes. Ranges are as follows:

SOFT 1.33 AND LOWER    SOFT 1.34 AND HIGHER

Full Scale:

5A: 1 Torr  
5B: 1000 Torr  
5C: 10 Torr

Full Scale:

5A: 1000 Torr  
5B: 100 Torr  
5C: 10 Torr  
5D: 1 Torr  
5E: 0.1 Torr  
5F: special

An analog "0-10V" output (normally 0 to 10VDC) is available at the connector in the center of the panel. An optional 0 to 10 mvDC is also available (See Section 902). There are three terminals available. The center terminal is a common ground and negative terminal for both the upper and lower diaphragm stations. The upper and lower terminals are the positive signals for the upper and lower stations, respectively.

Between the cable connector and the analog "0-10V " output terminal is a ZERO potentiometer. This potentiometer is used, if required, to adjust the zero at a pressure two decades below the lower limit of the gauge. A second SPAN potentiometer is used to adjust the 5\_\_ capacitance diaphragm gauge at the maximum (full scale) value for the sensor.

**NOTE:**

Capacitance Diaphragm Gauge Tubes with a range of greater than 1 Torr will **not** control the Cold Cathode automatic turn on!

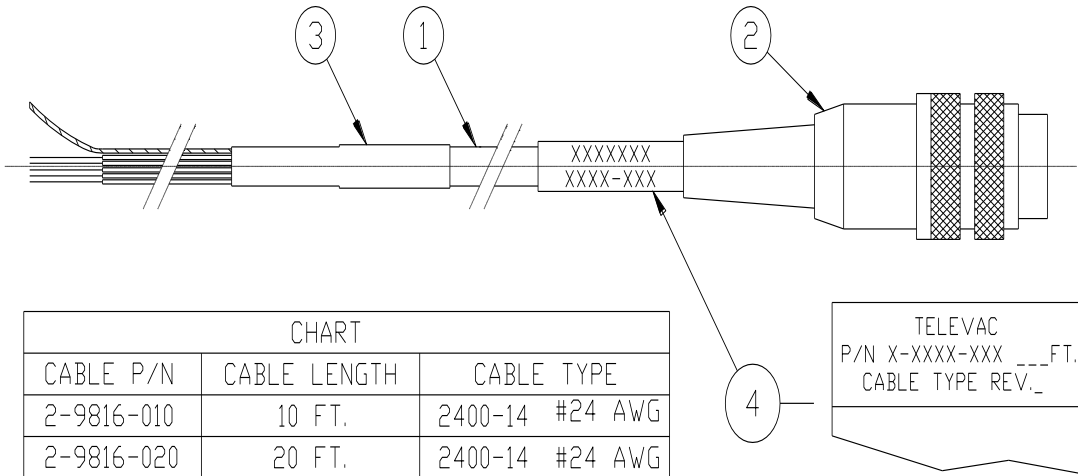
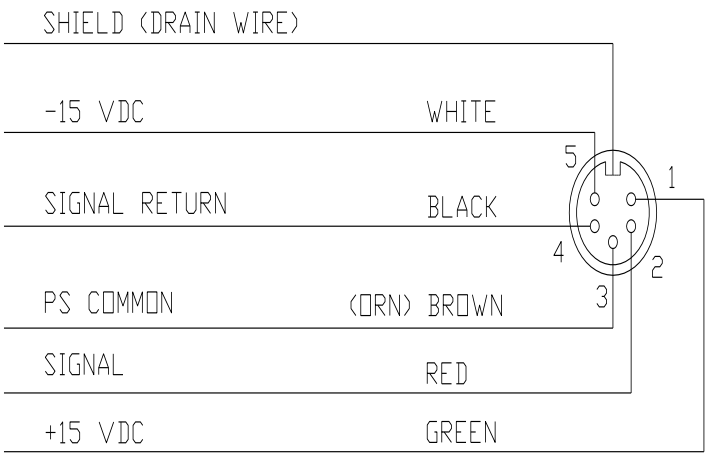

CHART		
CABLE P/N	CABLE LENGTH	CABLE TYPE
2-9816-010	10 FT.	2400-14 #24 AWG
2-9816-020	20 FT.	2400-14 #24 AWG
2-9816-035	35 FT.	2400-021 #22 AWG
2-9816-050	50 FT.	2400-021 #22 AWG





**400 OPERATION**

Turn the power switch, located on the rear panel, to the ON position. If the gauge is installed in a rack or cabinet where the power switch is not accessible, power may be left on without damage to the instrument.

**401 DISPLAY DESCRIPTION AND DEFINITIONS**

Fig. 4.1 shows the front panel of the gauge controller with all LED segments displayed. A definition of each display is provided.

**STATION NUMBER** - This number corresponds to the sensor whose pressure (vacuum) is being displayed. This sensor is located at a particular location in the vacuum system.

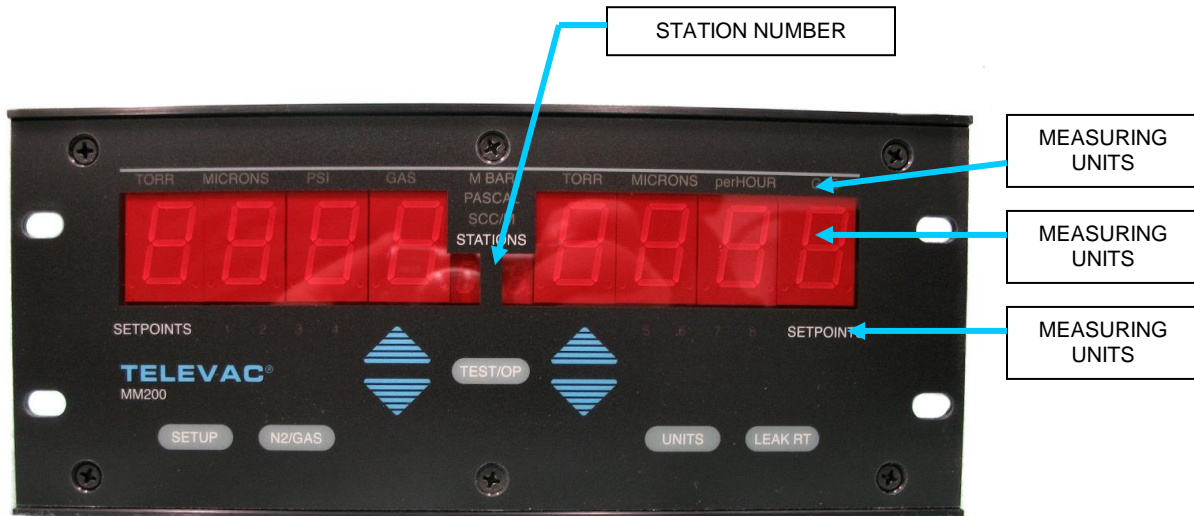

Figure 4.1 - Front Panel of Gauge Controller

The gauge controller can have one (1) to ten (10) stations. The station numbers are normally factory assigned but can be re-assigned at installation. Stations are selected via the UP/DOWN arrows. The 10 th station, if installed, is indicated by an "A".

**DATA DISPLAY** - The simultaneous display of two stations each present 4 digits of measurement (normally for thermocouple #1 and the primary ionization gauge - cold cathode or hot cathode). It can also display programming data for the station or setpoint selected via the UP/DOWN



pushbuttons. The ionization gauge display flashes "OFF" until it is turned on by the controlling thermocouple station (usually TC#1). The high voltage to the gauge tube will be off during this time.

Normally, the thermocouple station data are indicated in microns in a numerical format for pressures above 1 micron. The ionization gauge stations are indicated in Torr below 1 micron ( $10^{-3}$  Torr) using an exponential format. In the exponential format, positive and negative exponent can be used. The display of negative and positive exponents is done as follows:

$3.0 \times 10^{-7}$  is displayed as 3.0-7  
 $3.0 \times 10^{+2}$  is displayed as 3.0E2

**UNITS: TORR, MICRONS, MBAR, PA, PSI** - Use the UNITS pushbutton to select the desired pressure measurement unit to be displayed. Also available is MICRONS per HR used for leak rate and, in the future, SCC/M for flow rate display.

**GAS TYPE: (N<sub>2</sub> or GAS)** - These abbreviations indicate the gas type that is being measured by the selected sensor. The gas type has been selected by the operator via front panel programming using the N2/GAS pushbutton. The alternate gas type is factory programmed and is typically argon. Display letters periodically flash **ArG** (for argon) and **He** (for helium gas). Other gas types may be available on special order.

**LEAK RATE INDICATOR** - This is a trend representation of displayed data and indicates the rate of change of pressure. Full scale is approximately 9999 microns/hour. A positive number indicates pressure increases, a negative number indicates pressure decreases. This feature is activated via the LEAK RT pushbutton.

**SETPOINT RELAY STATUS NUMBERS** - The setpoint relay status lights show the status of each relay. If the number is illuminated, then the relay has been energized due to the pressure on the assigned sensor falling below the "on" setpoint. These numbers are not lighted during the self-diagnostic function. They are out during the initialization routine after power-up. Relays are located on the optional setpoint module board.

## 402 ERROR INDICATIONS

Using internal diagnostics, the gauge software system continuously monitors the unit to verify proper operating conditions during power-up and normal operations. Any error conditions that are detected are displayed on the LED in the form of an error code message reading "Err" in the data display. This display comes up automatically after power-up or whenever the self-diagnostic test is run. The display also indicates the particular error condition detected. Refer to Section 502.1 for a more detailed explanation of error messages.



**403 KEYPAD DESCRIPTION**

Fig. 4.2 shows the front panel of the gauge controller with the various control pushbuttons identified.

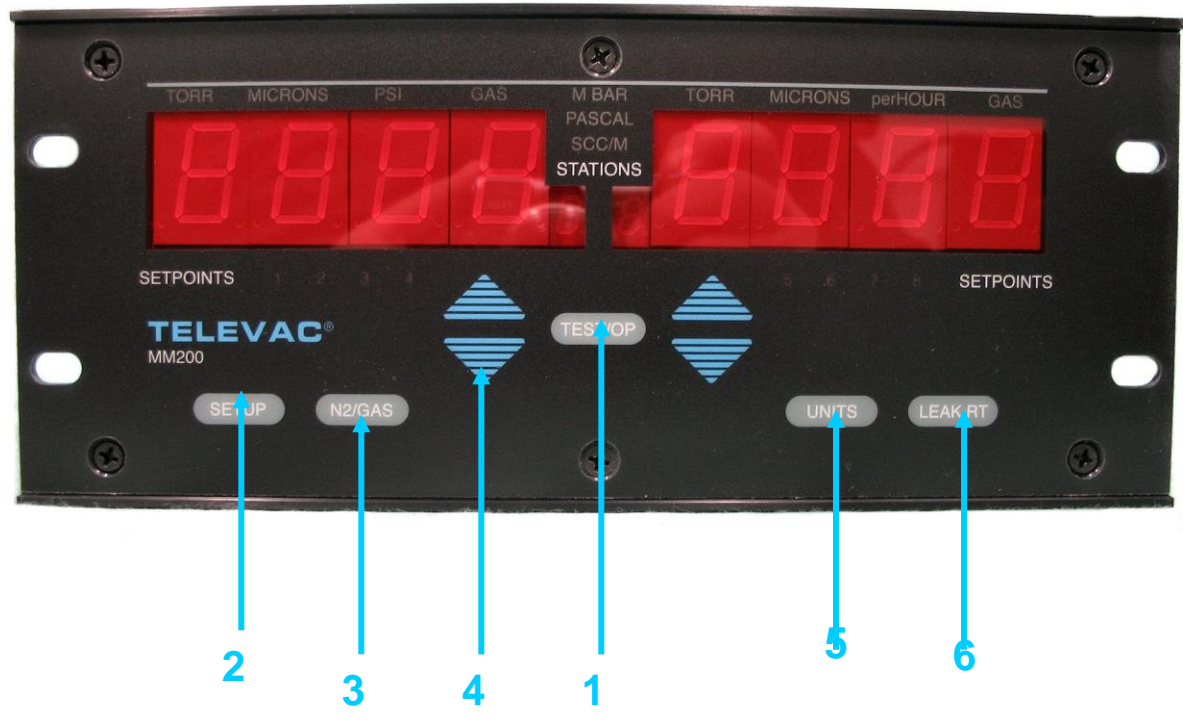

Fig. 4.2 - Control Pushbuttons



## PUSHBUTTON FUNCTIONS

1. **TEST/OP PUSHBUTTON** - Returns the instrument to normal operation at any time when in the SETUP mode. Initiates the Self-diagnostic test.
2. **SETUP PUSHBUTTON** - Allows PCR upper and lower setpoints to be viewed. Allows UP/DOWN arrows to raise or lower setpoints unless the SETUP switch on the optional RS232 module is in the LOCK position.
3. **N2/GAS PUSHBUTTON** - Change gauge sensitivity to correspond to a gas other than air or nitrogen (N<sub>2</sub>). Gauges other than diaphragm types respond differently to different gases. (See Section 700). The program uses argon for the other gas unless otherwise programmed at factory. This function is inhibited when the SETUP switch on the optional RS232 module is in the LOCK position. (Also see Section 502.5).
4. **UP/DOWN ARROWS** - Incrementally increase or decrease the number of the stations being displayed. Increases or decreases the PCR setpoint values when the lockout switch is in the ENABLE position; reassigns set point assignments. (See Section 502 for details).
5. **UNITS PUSHBUTTON** - Changes units of measurement for pressure from the default units to: TORR, MICRON, PSI, MBAR, PASCAL. This does NOT change the analog 0-10V output values.
6. **LEAK RT PUSH BUTTON** - After a 15 second delay, displays average leak rate (or rate of change of pressure) in the right hand display when depressed. Display is in MICRONS per HR.

## 404 RELAY SETPOINTS

Relay setpoints are used to control the four relay outputs located on the optional Setpoint Relay Module. Each relay has a pair of setpoints, an upper and a lower value. These setpoints correspond to the pressure value of a specified sensor. The relay is energized when the pressure goes below the "on" setpoint, and de-energized when the pressure goes above the "OFF" setpoint. When the pressure is between the two setpoints, the relay remains in its current state. To adjust the setpoints see Section 502.

Since the relays have a flash coating of gold, they can be used as either "dry circuit" (low power) or power relays (up to 5 Amps). Use of the relay as a power relay forever impairs its use as a "dry circuit" relay.

The RELAY messages on the display indicate the status of the relays. If the RELAY is energized, the corresponding relay number light is on. If it is de-energized, the light is off.



## RANGE OF USE

For relays assigned to the following types of sensors:

Cold Cathode - any value up to  $10^{-2}$  Torr

Convection - 1 micron to 990 Torr

Diaphragm - 1 to 990 Torr

Hot Cathode - any value up to  $10^{-2}$  Torr

Thermocouple - 1 micron to 3 Torr.

Settings above 3 Torr, if required, will have to be set experimentally and will differ depending on whether the pressure is increasing or decreasing.

## CHANGING SENSOR ASSIGNMENT

When changing sensor assignment TO A DIFFERENT TYPE OF SENSOR the following step must be taken to assure proper operation:

Use the DOWN ARROW to RUN THE SET POINT TO ZERO BEFORE RESETTING IT to the desired setpoint.

Example 1: Controlling a Cross-over Valve.

Cross-over is the point at which the high vacuum pump (e.g., diffusion pump) is connected to the vacuum system. This is usually done automatically at a pressure in the range of 80 to 100 microns.

Relay 1 is set to energize at a pressure of 80 microns on the signal from thermocouple sensor #1, which monitors the pressure in the main chamber. When the pressure drops below 80 microns, a sequence of steps is initiated by the change in status of the relay, namely:

The roughing valve is closed, then the foreline is opened and then the large main valve is opened. This connects the high vacuum pump directly to the vacuum chamber and allows the high vacuum pumping to proceed.

A different upper and lower setpoint are programmed. While the system is pumping down, the relay does not change its state until the pressure falls below the lower setpoint and does not revert back to its normal position until the pressure rises above the upper setpoint.

Example 2: Pressure Control

The relay is set up in a similar manner in this example. In this case, the relay controls a valve on a gas inlet line to roughly control the system pressure between 1 and 4 Torr.



#### 405 ANALOG 0-10V OUTPUTS

**0-10V OUTPUTS** - Recorder outputs of 0 to 10 volts (or mV) are available for all installed stations. (\* See note). The 0-10V outputs are in units of measurement, which are "normally" used, in the USA, for the sensor being used. When the UNITS pushbutton is pushed to display alternate units of measure, the recorder output remains in the original units of measurement so that no discontinuity occurs in the output data due to pushing this button.

The various outputs are available are shown in Table 4.1 along with the "normal" units of measurement.

linear  
linear per decade  
logarithmic  
non-linear "traditional"

These various outputs can be assigned by the Televac factory or by the user via RS232 /RS485. See Table 4.1 and Section 1000 for details.

\* Note : Special 0 to 5 VDC option is available in many cases.



**4A CONVECTION GAUGE OUTPUTS OPTIONS**

TORR/ MICRON READS	TRDL OUT NON-LINEAR	LINEAR PER DECADE 1 Volt per DECADE (default)	LINEAR 10V = 1000 MICRONS	LINEAR 10V = 10 TORR	LOG 1.67V per DECADE
RS232 CODE	Jumper	R4AN	R4AU	R4AT	R4AL
	Volts	Volts	Volts	Volts	Volts
0-	0.000	4.000	0.000	0.000	-
1 μ	0.013	4.100	0.010	0.001	0.000
5 μ	0.065	4.500	0.050	0.005	1.165
10 μ	0.124	5.100	0.100	0.010	1.667
20 μ	0.238	5.200	0.200	0.020	2.168
30 μ	0.344	5.300	0.300	0.030	2.462
40 μ	0.450	5.400	0.400	0.040	2.670
50 μ	0.546	5.500	0.500	0.050	2.832
60 μ	0.638	5.600	0.600	0.060	2.964
70 μ	0.730	5.700	0.700	0.070	3.075
80 μ	0.816	5.800	0.800	0.080	3.172
90 μ	0.898	5.900	0.900	0.090	3.257
100 μ	0.980	6.100	1.000	0.100	3.333
150 μ	1.350	6.150	1.500	0.150	3.627
200 μ	1.670	6.200	2.000	0.200	3.835
300 μ	2.285	6.300	3.000	0.300	4.129
400 μ	2.630	6.400	4.000	0.400	4.337
500 μ	2.992	6.500	5.000	0.500	4.498
800 μ	3.824	6.800	8.000	0.800	4.838
1T	4.226	7.100	10.000	1.000	5.000
2 T	5.440	7.200	13.500	2.000	5.502
3T	6.080	7.300	"	3.000	5.795
4T	6.440	7.400	"	4.000	6.003
5T	6.772	7.500	"	5.000	6.165
10 T	7.412	8.100	"	10.000	6.667
20 T	7.782	8.200	"	13.500	7.168
30 T	7.910	8.300	"	"	7.462
40 T	7.936	8.400	"	"	7.670
50 T	7.976	8.500	"	"	7.832
60 T	8.006	8.600	"	"	7.964
80 T	8.042	8.800	"	"	8.172
100 T	8.072	9.100	"	"	8.333
120 T	8.124	9.120	"	"	8.465
150 T	8.180	9.150	"	"	8.627
160 T	8.224	9.160	"	"	8.674
170 T	8.256	9.170	"	"	8.717
180 T	8.280	9.180	"	"	8.759
200 T	8.328	9.200	"	"	8.835
300 T	8.756	9.300	"	"	9.129
400 T	9.208	9.400	"	"	9.337
500 T	9.544	9.500	"	"	9.498
600 T	9.772	9.600	"	"	9.630
760 T	10.000	9.760	"	"	9.801
900 T	10.142	9.900	"	"	9.924
1000 T	10.232	10.000	"	"	10.000





**7B2 - 0-10V OUTPUT OPTIONS**

<b>RS 232</b>	<b>R7BM</b>	<b>R7BN</b>	<b>R7BE</b>	<b>R7BL</b>
	<b>Volts</b>	<b>Volts</b>	<b>Volts</b>	<b>Volts</b>
1X10-3	10.0	10.000	10.00000	10.00000
9X10-4	9.8	9.000	9.88561	9.84747
8X10-4	9.6	8.000	9.75772	9.67697
7X10-4	9.4	7.000	9.61275	9.48366
6X10-4	9.2	6.000	9.44538	9.26050
5X10-4	9.0	5.000	9.24743	8.99657
4X10-4	8.8	4.000	9.00515	8.67353
3X10-4	8.6	3.000	8.69280	8.25707
2X10-4	8.4	2.000	8.25257	7.67010
1X10-4	8.2	1.000	7.50000	6.66667
9X10-5	7.8	0.900	7.38561	6.51414
8X10-5	7.6	0.800	7.25772	6.34363
7X10-5	7.4	0.700	7.11275	6.15033
6X10-5	7.2	0.600	6.94538	5.92717
5X10-5	7.0	0.500	6.74743	5.66323
4X10-5	6.8	0.400	6.50515	5.34020
3X10-5	6.6	0.300	6.19280	4.92374
2X10-5	6.4	0.200	5.75257	4.33677
1X10-5	6.2	0.100	5.00000	3.33333
9X10-6	5.8	0.090	4.88561	3.18081
8X10-6	5.6	0.080	4.75772	3.01030
7X10-6	5.4	0.070	4.61275	2.81699
6X10-6	5.2	0.060	4.44538	2.59384
5X10-6	5.0	0.050	4.24743	2.32990
4X10-6	4.8	0.040	4.00515	2.00687
3X10-6	4.6	0.030	3.69280	1.59040
2X10-6	4.4	0.020	3.25257	1.00343
1X10-6	4.2	0.010	2.50000	0.00000
9X10-7	3.8	0.009	2.38561	
8X10-7	3.6	0.008	2.25772	
7X10-7	3.4	0.007	2.11275	
6X10-7	3.2	0.006	1.94538	
5X10-7	3.0	0.005	1.74743	
4X10-7	2.8	0.004	1.50515	
3X10-7	2.6	0.003	1.19280	
2X10-7	2.4	0.002	0.75257	
1X10-7	2.2	0.001	0.00000	





<b>MM200 0-10V OUTPUT FORMATS</b>					
<b>1E &amp; 1F DIAPHRAGM GAUGES</b>					
<u>RS232 CODE</u>	<u>display abbr</u>	<u>NAME</u>			
<b>R1EN</b>	<b>Linr</b>	<b>LINEAR</b>	<b>0-1000 TORR/10BAR</b>	<b>0-10V</b>	<b>10V =1000 TORR/10BAR-----</b>
*		LIN/DEC	"	2.0V/DEC	"
<b>RIEL</b>	<b>LoG3</b>	<b>LOG</b>	"	<b>3.33V/DEC</b>	"
<b>2A THERMOCOUPLE GAUGES</b>					
<b>R2AN</b>	<b>Ln1t</b>	<b>LINEAR</b>	<b>0-1000 MICRONS</b>	<b>0-10V</b>	<b>10V =1000 MICRONS-----</b>
R2AL	LoG3	LOG	0-1000 MICRONS	3.33V/DEC	10V =1000 MICRONS
R2AT	2Atr	2A TRAD'L	0-20,000 MICRONS	0-10V	10V = 0 MICRONS (RL)
R2AC	2Ctr	2C TRAD'L	0-20,000 MICRONS	0-10V	10V = 0 MICRONS (RL)
R2AR	-Lin	LIN REV'D	1000 MICRONS-0	0-10V	10V = 0 MICRONS (RL)
<b>3F, 3D &amp; 3E HOT CATHODE GAUGES</b>					
<b>R3DM</b>	<b>L-d1</b>	<b>LIN/DEC</b>	<b>10-11 TO 10-2 TORR</b>	<b>1.00V/DEC</b>	<b>10V = 10-2 TORR-----</b>
R3DL	LG10	LOG	"	1.00V/DEC	10V = 10-2 TORR
R3Dx	Ln-x	LINEAR	0-10-x TORR	0-10V/10v =	10V = 10-x (8=>x>, =2)
R3FM	L-d1	LIN/DEC	10-11 TO 10-2 TORR	1.00V/DEC	9V =10-2 TORR -----
R3FL	LG10	LOG		1.00V/DEC	9V =10-2 TORR
R3Fx	Ln-x	LINEAR	0-10-x TORR	0-10V	10V = 10-x(8=>, >x>, =2)
<b>4A CONVECTION GAUGES</b>					
<b>R4AN</b>	<b>L-d1</b>	<b>LIN/DEC</b>	<b>10-3 TO 1000 TORR</b>	<b>1.00V/DEC</b>	<b>10V = 1000 TORR-----</b>
R4AU	Ln1t	LINEAR	0-1000 MICRONS	0-10V	10V =1000 MICRONS
R4AT	Ln10	LINEAR	0-10 TORR	0-10V	10V = 10 TORR
R4AL	LoG6	LOG	10-3 TO 1000 TORR	1.67V/DEC	10V = 1000 TORR
JMPR		4A NON-LIN	10-3 TO 1000 TORR	0-10V	10V = 760 TORR
*		2A TRAD'L	0-1000 MICRONS	0-10V	10V = 0 MICRONS (RL)
*		2C TRAD'L	0-20,000 MICRONS	0-10V	10V = 0 MICRONS (RL)
<b>5A,B,C,D,E,F CAP DIAPHRAGM GAUGES</b>					
<b>R5AN</b>	<b>Linr</b>	<b>LINEAR</b>	<b>0-FULL SCALE</b>	<b>0-10V</b>	<b>10V = FS-----</b>
R5AL	LoG3	LOG	3 DECADES	3.33V/DEC	10V = FS 5A FS = 1000 TORR 5D FS = 1 TORR 5B FS = 100 TORR 5E FS = 0.1
<b>7B COLD CATHODE GAUGE MODULE (2-6200-227)</b>					
<b>R7BM</b>	<b>L-d2</b>	<b>LIN/DEC</b>	<b>10-7 TO 10-3 TORR</b>	<b>2.00V/DEC</b>	<b>10V = 10-3 TORR-----</b>
R7BL	LoG3	LOG	10-6 TO 10-3 TORR	3.33V/DEC	10V = 10-3 TORR
R7BE	LoG4	EXT'D LOG	10-7 TO 10-3 TORR	2.50V/DEC	10V = 10-3 TORR
R7BN	Linr	LINEAR	10-6 TO 10-3 TORR	0-10V	10V = 10-3 TORR
R7BA	7Atr	7ACTRADL	10-5 TO 10-3 TORR	0-10V	10V = 10-3 TORR
R7BT	B7b	B7B2 TRADL	10-7 TO 10-3 TORR	0-10V	10V = 10-3 TORR
<b>7E COLD CATHODE GAUGE</b>					
<b>R7EM</b>	<b>L-d1</b>	<b>LIN/DEC</b>	<b>10-8 TO 10-2 TORR</b>	<b>1.00V/DEC</b>	<b>10V = 10-2 TORR (4-10V)-----</b>
R7EL	LoG6	LOG	10-8 TO 10-2 TORR	1.67V/DEC	10V = 10-2 TORR (0-10V)
R7Fx	Ln-x	LINEAR	0 TO 10-x TORR	0-10V	10V = 10-x TORR (7=>, >x>, =2)
<b>7F (7FC, 7FCS) COLD CATHODE GAUGE</b>					
<b>R7FM</b>	<b>L-d1</b>	<b>LIN/DEC</b>	<b>10-11 TO 10-2 TORR</b>	<b>1.00V/DEC</b>	<b>9V = 10-2 TORR-----</b>
R7FL	LG10	LOG	10-11 TO 10-2 TORR	1.00V/DEC	9V = 10-2 TORR
R7x	Ln-x	LINEAR	0 TO 10-x TORR	0-10V	10V = 10-x TORR (8=>, >x>, =2)
Note: "M" is displayed as "ii" RECUT205 110598			<b><u>SEND "SE" AFTER SENDING NEW FORMAT COMMAND TO RETAIN IT AFTER POWER OUTAGE</u></b>		

Table 4.1



## 0-10V OUTPUT OPTIONS

See Section 1000 for curves of voltage-vs-pressure for the outputs listed in Table 4.1.

**LINEAR** - This is compatible with linear recorders and linear chart paper. The range of display is limited. Only the top two decades can be easily read. Below this point the output drops to less than 0.1 volts for a full-scale output of 10 V.

**LINEAR PER DECADE** - This output is best used when the 0-10V output covers a range of several decades such as  $10^{-3}$  to  $10^{+3}$  Torr and a "strip chart" recorder with linear paper is being used to record the data. In the example mentioned, the range covers six (6) decades.

Since the top of any decade (eg.  $10 \times 10^{-3}$ ) is the same as the bottom of the next higher decade, (eg.  $1 \times 10^{-2}$ ), there are only 9 divisions in a decade. A six decade output, for example, which is linear within each decade can best be plotted on chart paper with six (6) major divisions and nine (9) minor divisions. This chart paper is non-standard. To accommodate the use of a standard linear chart paper with 10 major divisions and 10 minor divisions, the 0-10V output is made discontinuous between the top of one decade and the bottom of the next higher decade.

With the linear per decade analog output, six decades can be plotted on one standard chart and the value of vacuum (pressure) can be easily read. The value of the voltage within any decade is equal to the value at the top of the next lower decade plus a variable adder voltage. For a 1 V/decade output the adder for  $5 \times 10^{-x}$  would be .5 volts.

**LOGARITHMIC** - This output is best used when the 0-10V output covers a range of several decades such as  $10^{-3}$  to  $10^{+3}$  Torr and a "data acquisition system" is being used to record the data. In the example mentioned, the range covers six (6) decades. The output curve (voltage-vs-pressure) is a continuous output from 0- 10 volts (or mV) covering the entire range with a slope of "X" volts/decade.

**2A NON-LINEAR** - This output matches the direct voltage-vs-pressure of the old 2A instrument with a 0- 10 volt output. This output is best used when a "strip chart" recorder with pre-printed Televac 2A non-linear paper is being used to record the data.

**2C NON-LINEAR** - This output matches the direct voltage-vs-pressure of the old 2C instrument with a 0- 10 volt output. This output is best used when a "strip chart" recorder with pre-printed Televac 2C non-linear paper is being used to record the data.

**7AC NON-LINEAR** - This output matches the direct voltage-vs-pressure of the old 7AC instrument with a 0- 10 volt output. This output is best used when a "strip chart" recorder with pre-printed Televac 7AC non-linear paper is being used to record the data.

**7B2 NON-LINEAR** - This output matches the direct voltage-vs-pressure of the old 7B2 instrument with a 0- 10 volt output. This output is best used when a "strip chart" recorder with pre-printed Televac 7B2 non-linear paper is being used to record the data.



## 406 INITIAL OPERATIONAL SETUP SEQUENCE

Turn power ON. Switch located on gauge controller rear panel. Observe pressure readings (with a cable and a sensor plugged in).

### PRESSURE READINGS

Before pumpdown, the chamber thermocouple gauge will read 20.0 Torr and the cold cathode gauge will read "OFF". As pumpdown proceeds, the thermocouple gauge will start to read pressures below 20.0 Torr. When it gets to 10 microns, the cold cathode gauge will be powered and will start to display a reading. Other gauge tube readings are observed using the UP/DOWN pushbuttons.

### RELAY SETUP

The SETUP pushbutton is used to control functions. They are controlled in the following sequence:

1. Cold Cathode gauge setup - if module is present
2. Hot Cathode gauge setup - if module is present
3. Relay setpoints/assignment - if module is present

If module is not present, this step is skipped. See section 502.3 for Hot Cathode and cold cathode setup procedures if these modules are present. For relay setup proceed as follows:

1. Push SETUP button as many times as is required to see the following display
  - a. SP1
  - b. STATION 1 (blinking) or any other station [Change assigned station, if required.  
Use UP/DOWN pushbuttons]
  - c. Sensor Type (e.g., 2A)
2. Push SETUP button to display
  - a. "on" value of SP 1
  - b. STATION 1 (not blinking)
  - c. Change "on" value, as desired, with either set of UP/DOWN arrows.
3. Push SETUP button to display
  - a. "OFF" value of SP1
  - b. STATION 1 (not blinking)
  - c. Change "OFF" value, as desired, with UP/DOWN arrows.
4. Push TEST/OP button to return to NORMAL display at any time.
5. Push SETUP button to display SP 2, 3 & 4 and change values as desired as described in steps 3 & 4.
6. Push SETUP button to return to NORMAL display.

NOTE: Station #1 is chosen as an example and may be other than a thermocouple station. Also, any active station may be selected to control the relays as noted in 1b. Additional information can be found in Section 502.3 under Relay Setpoints.

160Phone:(215) 947-2500 fax:(215) 947-7464 e-mail:sales@televac.com web site:www.televac.com

MM-200\_im REV M

Page 50 of 160

**GAS**

1. Push N2/GAS button to change from nitrogen or air mode to GAS mode (normally ARGON). Controller accurately displays pressure value of gas other than nitrogen or air.
2. Push N2/GAS button to return display to normal nitrogen or air mode.

**MEASUREMENT UNITS**

1. Push units button to select desired unit of measure other than TORR or MICRONS such as PASCAL, MBAR, and SCC/M. Continue to push until desired units are displayed.

**LEAK RATE**

1. Push LEAK RT button to display leak rate LED. After 15 seconds the leak rate value is displayed under the MICRONS/HR heading. Value is average leak rate from time pushed. Push again to return to normal operation.

Leak rate is measured using the data from station number "1". Currently leak rate is only processed for thermocouple and convection type gauges. Therefore, no attempt should be made to use the leak rate function, if station number "1" is not assigned to one of these station types.



#### 407 HOT CATHODE MODULE (Mini BA) (Software ver. 2.31 or higher)

The hot cathode mini-BA operates in the range of  $10^{-2}$  to  $10^{-11}$  Torr. It is recommended to enter the setup mode and select the setting that will best fit your application before continuous operation. Refer to the setup section in the manual.

#### SENSITIVITY

The sensitivity of the hot cathode mini-BA can vary slightly between gauges. In order to achieve the most accurate reading from the gauge the sensitivity can be adjusted in setup. This factory-preset value is 10.0 (1 / Torr). It can be set from 5.0 to 20.0. To set this value, refer to the setup section of the manual.

#### DEGAS

Over time and depending on the process gases used, the gauge can become contaminated. Degassing the gauge will clean the tube of these impurities. Degas increases the emission current and raises the grid voltage. After degas, it may be several hours for the gauge to become stable. In order to degas the gauge, the pressure must be below  $10^{-5}$  Torr. To degas the gauge, refer to the setup section of the manual.

#### FILAMENT

There are 2 filaments in the hot cathode mini-BA gauge. To change the filament number, refer to the setup section of the manual.



## 500 SETUP

Stored parameter data may be viewed and modified by the user. Parameter values are modified by using the UP/DOWN arrow keys. The longer the arrow keys are held down the faster the values increase or decrease.

### 501 INITIALIZATION

When power is applied to the instrument, an initialization program is performed. The initialization was briefly discussed in Section 203 and consists of the following steps:

**INITIAL DISPLAYS** - The front panel (shown in Fig. 2.2) is used to observe the displays and to execute the initial "self-test" of the unit. Turn the power on by pressing the rear panel power switch to ON. The initial display shows the word "SOFT" followed by a number indicating which software version is present (See Fig. 2.3).

This message is followed by an error code, if any errors are present (See Section 900). If no errors are present, the initial display of two installed sensor modules appears.

When the initial display appears, the default mode is to display the non-ion type station with the lowest station number in the right-hand display. This is usually a thermocouple, convection or diaphragm gauge. Since no cable and/or sensor is connected, the "CABL" message blinks. If a display does not appear, check the power outlet and the main fuse on the rear of the unit.

The left-hand display shows the ion type station with the lowest station number if there are any ion type stations, if not, then the next lowest station number is displayed. Typically the primary ionization station, which is cold cathode station #7 in the example shown in Fig. 2.2 and Fig. 2.4. Since the high voltage power is off, the display reads "OFF".

During the initialization process, the following steps take place:

1. The station displays and the various LEDs go blank.
2. The A/D converter is calibrated.
3. Each station is interrogated to determine the type of sensor installed, if any. In normal operation only those stations that are installed are measured routinely and available for display. Also, only those stations are available for setpoint assignment.
4. The setpoint boards are then interrogated to determine which set points are installed. Only installed set points are available for selection during the "FUNCTION" operation. Setpoint modules must be set up with SP identification in either 1, 2, 3, 4 or 5, 6, 7, 8 sequences only.
5. Setpoint selections and settings that were in effect when power was last applied are then read from the nonvolatile memory. These selections and settings are then used as the current ones.
6. If any error is detected, the instrument goes into the error function routine. The message "Err" plus a code is displayed. (See Section 502.1).
7. The instrument then resumes normal operation with the right-hand display displaying the reading of the first installed (lowest position number) thermocouple or convection type gauge. These type gauges are typically used to disable the power to all ionization gauges that are installed when the pressure exceeds a preset pressure value (typically 10 microns for cold cathode gauges). The left-hand display shows the primary cold cathode gauge (the one with the lowest station number).



## 502 USE OF PUSHBUTTONS

### TEST/OP PUSHBUTTON

**RETURN TO NORMAL OPERATION** - A pushbutton labeled TEST/OP is located between the two sets of UP/DOWN arrows. Pressing this button at the end of any step listed below under SETUP causes the instrument to return to normal operation. Any settings that have been changed are stored in nonvolatile memory in an EEPROM, and are the default settings should power be turned off and then back on (See Fig. 4.2).

**SELF DIAGNOSTIC TEST** - The TEST/OP pushbutton is used to perform self diagnostics if pressed during normal operation. When TEST/OP is pressed in normal operation the two station displays go blank. The left-hand large display now shows "SELF", and the right-hand large display shows "tEST". The displays remain that way until the self-diagnostic test is complete, which is probably less than a second. During this time all pushbuttons are disabled.

At the completion of the self-test period, the display starts to flash alternate horizontal and vertical bars. The other display LEDs turn on with the horizontal bars. This is done so the operator may observe if any display segments are faulty.



Pressing the TEST/OP button again causes the left-hand large display to show "Err". If there are no errors the right-hand large display shows "none". Otherwise the right-hand large display shows one of the following, depending on what error or errors have been found:

"Err	nonE"	There are no errors.
"P 15	HIGH"	The +15 volt supply is high.
"P 15	LO"	The +5 volt supply is low.
"P 5	HIGH"	The +5 volt supply is high.
"P 5	LO"	The +5 volt supply is low.
"-12	HIGH"	The -12 volt supply is high*.
"-12	LO"	The -12 volt supply is low*.
"ProG"		The program memory is faulty.
"Adc"		The A/D converter is faulty.
"Err"		FIL                    shrt
		no E                  curr
		HP                    Shrt
		PrtY                  Err
		FrAn <sub>G</sub> Err
		Shut    dn

\* High and low with respect to the negative supply refers to absolute value.

Pressing TEST/OP again causes the next fault to be displayed if there is more than one fault. After the last fault (or "no err") is displayed, pressing the TST.OP button once returns the instrument to normal operation.

For software versions 2.03 and higher, pressing the TST/OP button twice in quick succession after the last fault, or "no err", display will result in display of the 0-10V output voltage formats for each installed sensor station with each subsequent push. After the last recorder format is displayed, the next button push returns instrument to normal operation. A complete listing of available 0-10V output voltage formats with their display codes and corresponding RS232 commands is shown in the following table on page 505A.

Across the bottom of the instrument is a door that pulls down to reveal those buttons, which are not normally used, in the day-to-day operation of the instrument. The location of the numbered sensors and the assignment of relays can be marked on the paper insert inside the door (See Fig. 2.2).





**UP/DOWN ARROWS**

Below each display is a pair of pushbuttons with UP/ DOWN arrows. During normal operation, these pushbuttons are used to change the station number being displayed. In this case they do not have any effect on the operation of the instrument as such, they only affect which station is being displayed. The function of the UP/DOWN arrows during setup is described below.

**SETUP PUSHBUTTON** (for versions 2.31 or higher, refer to Section 6.2, page 602)

The SETUP pushbutton is used to control functions. They are controlled in the following sequence:

1. Cold Cathode gauge setup - if module is present
2. Hot Cathode gauge setup - if module is present
3. Relay setpoints/assignment - if module is present

If module is not present, the corresponding step is skipped.

**1a. COLD CATHODE SETUP (For Software Version 1.29\* )**

Press SETUP

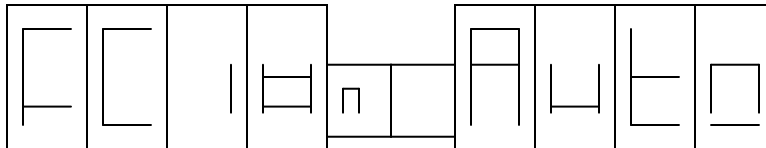

Normally CC is left in this Auto mode.

Press UP-ARROW

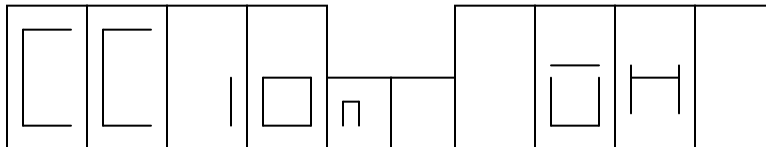

CC is on whenever unit is on.

Press DOWN- ARROW

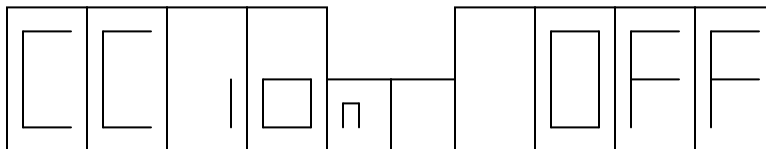

CC is off. Should return unit to Auto mode.

\* Use with 7B2 & 7E cold cathode modules 2-6200-227 or -223.



1b. COLD CATHODE SETUP (For Software Version 1.30 <sup>(1)</sup> and higher)

Power ON. Displays software version, does self-diagnostics. If everything is all right and the pressure is below 10 microns (e.g. "0") the display is as follows (assumes CC is station 5, TC is station 1):

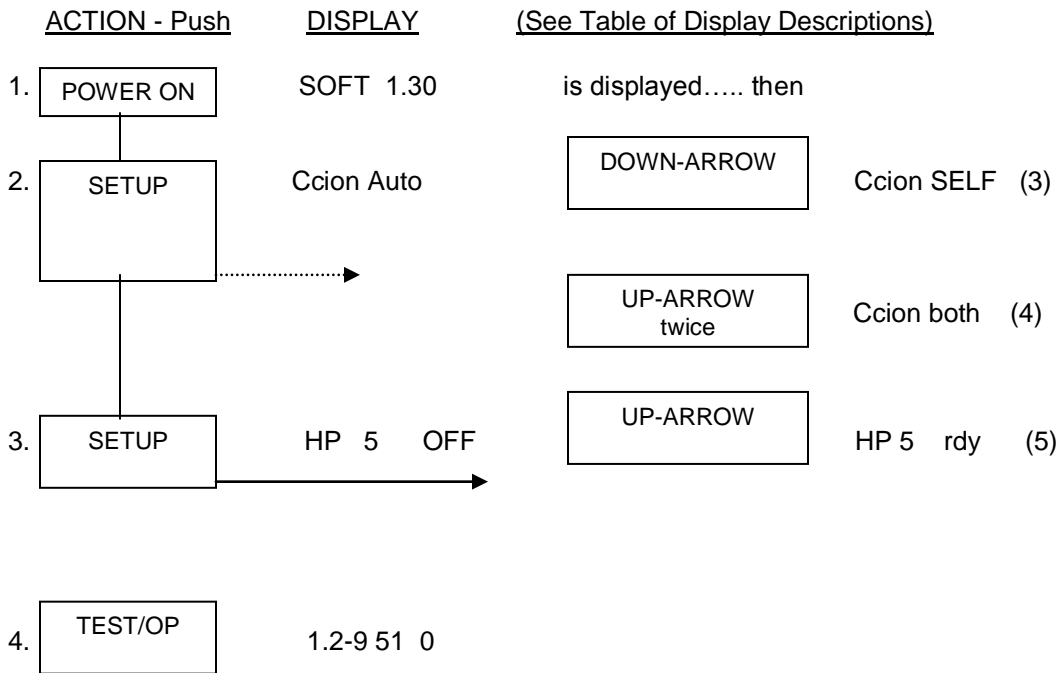

NOTES:

- (1) Required for 7F module 2-6200-245
- (2) Will skip to display of step 4 if in Auto mode (default setting for software 1.33 and higher)
- (3) HP = High Potential (voltage)
- (4) If turned off by overpressure, the CC must be reset by the front panel or by RS232.
- (5) CC display will come on if TC is below 10 microns ( Go to step 4)
- (6) Error codes which may be displayed:  
Shut dn = Unit was shut down overpressure safety

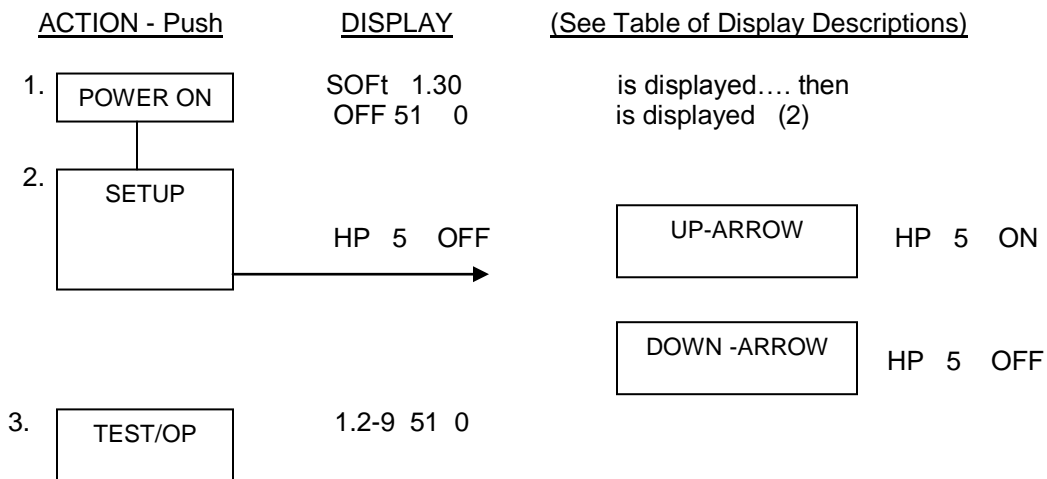

TABLE OF DISPLAY DESCRIPTIONS

SOFt 1.30	Software version number 1.30
OFF <sub>51</sub> 0	CC gauge (station 5) is OFF. (Flashing). TC gauge (station 1) is at 0 microns
CCion Auto	This means CC is turned off by thermoconductivity gauge pressure reading only and comes back on when pressure falls below 10 microns.
CCion SELF	This means CC is turned off by CC overpressure only.
CCion both	This means CC is turned off by both the CC overpressure and off and on by the thermo-conductivity gauge pressure reading. (Preferable). If turned off by overpressure, the CC must be reset by the front panel or by RS232.
HP <sub>5</sub> rdy	CC is ready to be turned on by TC reading below 10 microns.
1.2-9 <sub>51</sub> 0	Station 5 = $1.2 \times 10^{-9}$ Torr, Station 1 = 0 microns.

1c. COLD CATHODE SETUP (For Software Version 1.30 <sup>(1)</sup> and higher)  
WITH NO CONTROLLING THERMOCONDUCTIVITY GAUGE.

Power ON. Displays software version, does self diagnostics. If everything is all right and the pressure is below 10 microns (e.g. "0") the display is as follows (assumes CC is station 5, TC is station 1):





2a. 3D & 3E HOT CATHODE (I<sup>2</sup> R and Electron Beam Degas)  
 WITH A CONTROLLING THERMOCONDUCTIVITY GAUGE.

Power ON. Displays software version, does self diagnostics. If everything is all right and the pressure is below 10 microns (e.g. "0") the display is follows (assumes HC is station 5, TC is station 1):

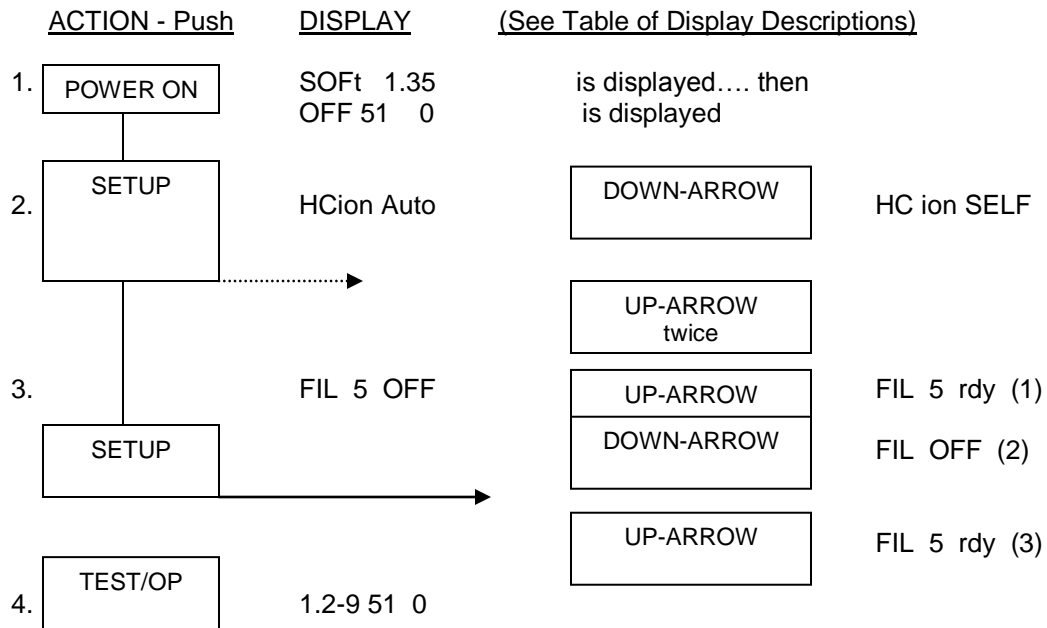

NOTES:

- (1) If filament comes on, GO TO Step 4. If not continue.
- (2) Switch filament selector switch on rear panel and continue. Use either up or down arrow.
- (3) Filament should be on. GO TO Step 4.
- (4) Error codes which may be displayed:
  - Shut dn = Unit was shut down overpressure safety
  - no E curr = Low emission current or wrong fil # connected.
  - HP Shrt = High voltage short, grid or filament grounded?



## TABLE OF DISPLAY DESCRIPTIONS

SOFT 1.35	Software version number 1.35
OFF <sub>51</sub> 0	HC gauge (station 5) is OFF. TC gauge (station 1) is at 0 microns
HCion Auto	This means HC is turned off by thermoconductivity gauge pressure reading only and comes back on when pressure falls below 10 microns.
HCion SELF	This means HC is turned off by HC overpressure only.
HCion both	This means HC is turned off by both the HC overpressure and off and on by the thermo-conductivity gauge pressure reading. (Preferable)
FIL <sub>5</sub> OFF	Filament is OFF.
FIL <sub>5</sub> rdy	Filament is ready to be turned on by TC reading below 10 microns.
FIL nbr2	Filament #2 is active.
FIL nbr1	Filament #1 is active.
FIL Err	Filament error.
1.2-9 <sub>51</sub> 0	Station 5 = $1.2 \times 10^{-9}$ Torr, Station 1 = 0 microns.
<sub>5</sub> OFF	Ion gauge is OFF
FIL <sub>5</sub> on	Filament is ON.
<sub>5</sub> 1.2-9	Station 5 = $1.2 \times 10^{-9}$ Torr.



2b. 3D & 3E HOT CATHODE (I<sup>2</sup> R and Electron Beam Degas)  
 WITH NO CONTROLLING THERMOCONDUCTIVITY GAUGE.

Power ON. Displays software version, does self-diagnostics. If everything is all right the display is as follows (assumes HC is designated as station number 5).

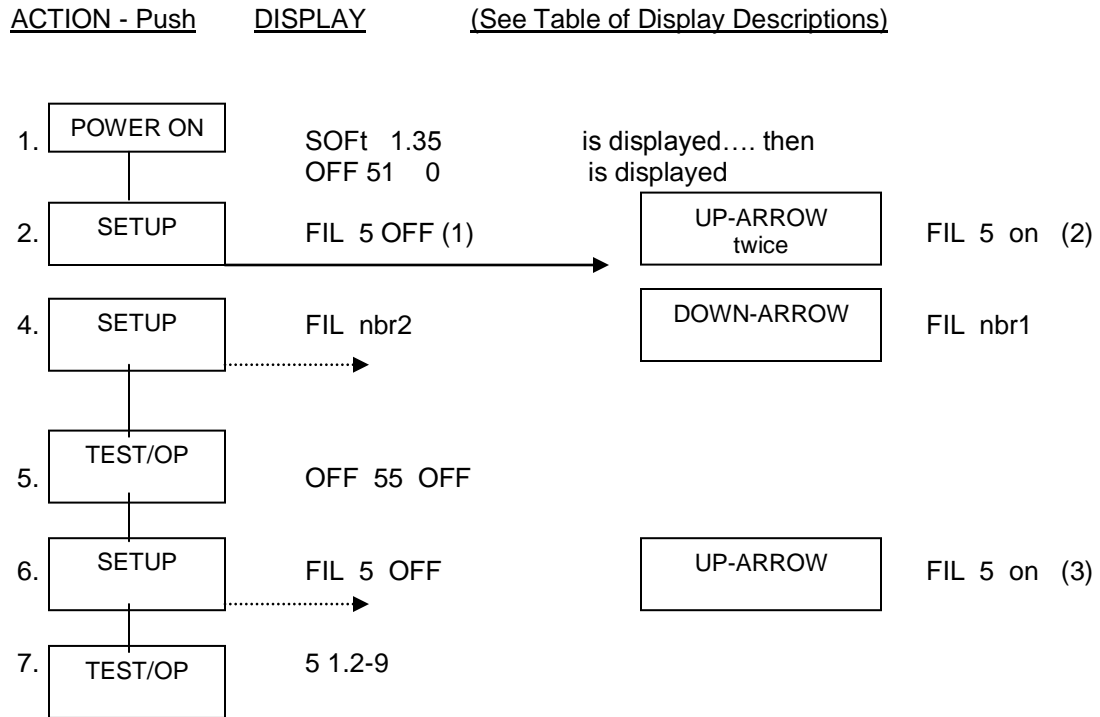

NOTES:

- (1) CAUTION - Pressure must be below 10 microns before continuing.
- (2) If filament comes on, GO TO Step 7. If not continue.



*DEGAS TIMER*

Press SETUP. FIL<sub>5</sub> on

Press SETUP again. If the pressure is below  $1 \times 10^{-5}$  Torr and the gauge tube is lighted, the following degas display will appear.

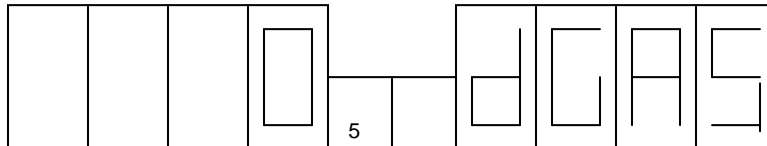

The DEGAS is off - 0 minutes.  
 Press the UP-ARROW to increase DEGAS time.  
 Press DOWN-ARROW to decrease.

PRESS SETUP OR TEST/OP TO RETURN TO NORMAL DISPLAY OF PRESSURE. Remaining degas time will flash on the right hand side display. Model 3E does not measure during DEGAS.

**3. RELAY SETPOINTS**

*SP #1 - STATION ASSIGNMENT* - When the SETUP button is pressed, the displays change their functions. When ion gauges (hot cathode and cold cathode) are present, the following displays follow those described for the ion gauges installed.

The large left-hand display changes to "SP 1", indicating that setpoint #1 is about to be assigned, set or simply viewed. The right-hand station display is blanked. The left-hand station display indicates the station that setpoint #1 is currently assigned to (e.g., station #1) and starts to blink. The right-hand large display then indicates what type of sensor is installed in that station, e.g., "2A" (See Fig. 5.1). Pressing either of the left-hand UP/DOWN arrows changes the station to which setpoint #1 is assigned.

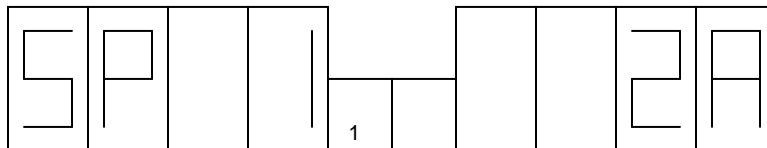

Fig. 5.1



NOTE: A relay can be "deactivated" (i.e., the relay is always de-energized) by giving its "on" setpoint a value of zero. This is independent of the value set for the "OFF" setpoint.

A relay can be "activated" (i.e., the relay is always energized) by giving its "on" setpoint, for relays assigned to thermocouple gauges, a value in excess of 1100 microns .

NOTE: After reassignment of a relay setpoint to a particular station, the new assignment is maintained in nonvolatile memory.

After the last installed setpoint "OFF" setting has been viewed and/or changed, pressing the SETUP button causes any changed values to be stored in nonvolatile memory and causes the instrument to return to normal operation.

### **UNITS PUSHBUTTON**

While all measurements are basically made in "native" units, they may be displayed in Pascals or millibars. The selection is made by way of the "UNITS" push button. The selection can be stored either through RS232 / RS485, or may be stored by going to Set Up and changing any set point, even if it is immediately changed back. Upon coming out of Set Up the selected units will be stored. When ever the unit is subsequently powered up the selected units will be the default units.

All Televac sensors have either Torr or Microns as their native units. The one exception is the Model 1F which has Bars as it's native unit.

When native units are the selected display units, the LEDs above the displays will automatically show the proper "TORR" or "MICRON" depending on the sensor and range.

If millibars or Pascals have been selected as the unit, then the displays above the sensor displays will remain extinguished, and the "MBAR" or "PASCAL" in the center of the instrument will light up and both displays regardless of the sensors will be displayed in those units.

The one exception is if one of the sensors is a Model 1F. In this case if native units are selected, then the LED above the station that is not a 1F indicates the proper unit, and the "MBAR" display flashes. If "MBAR" is selected then the "MBAR" LED stays lit (the other unit LEDs are out). If "PASCAL" is selected, both the "MBAR" and the "PASCAL" LEDs flash alternately. This should be avoided if possible. The operator would have to be fully aware of which sensor display is that of the 1F unit.





When this pushbutton is pressed in normal operation, the sensitivity of any thermocouple sensor displayed in the right hand display is adjusted to correspond to operation in a gas other than Nitrogen (or air). Typically the gas is argon and the default programming is for argon. The GAS display LED is illuminated. The alternate gas sensitivity stays with that station even if it is moved to the left hand display. Pressing this button a second time, when the desired station is displayed in the right hand display, causes the gas LED to go out, and the sensitivities to return to normal (i.e., air or nitrogen). Some or all of the thermocouple stations can be changed in this way one at a time.

The N2/GAS pushbutton is disabled when the LOCK/SETUP switch is in the LOCK position. It can be overridden by an external GAS switch, which can be connected via a connector marked "GAS SW" on the RS232 module. The connector is a NC connection until a mating plug is inserted. The external switch should be wired so that it is CLOSED for N2 and OPEN for the alternate gas.

### **LEAK RATE PUSHBUTTON**

When the leak rate pushbutton is pressed in normal operation, the MICRONS per HOUR display is illuminated. The right-hand display starts to indicate leak rate in microns per hour based upon the sensor associated with station #1, even if this display had been previously indicating another sensor or in some other units. The display is continuously updated based upon the change in pressure from the time when the button was first pushed. Initial readings are displayed after a 15-second delay. Typically a 15-minute waiting time is used to get a final reading. Pressing this button a second time returns the instrument to the set-up that was in effect before the button was pressed the first time. This feature applies to thermocouple and convection gauges only.

### **HANDLING UNITS**

Sensor signals are processed and linearized in "native" units of pressure; that is, the units, which are normally considered standard for the unit being processed:

Thermocouple	- microns
Convection	- microns or Torr (per Table 4.1)
Cap Dia	- microns or Torr
Ion (CC)	- Torr

Analog recorder outputs are in "native" units of pressure. Selection of alternate units on the display does not affect the recorder outputs. If this is not done, recorder charts read incorrectly when someone changes units with the front panel pushbutton.

Customers who desire recorder outputs to correspond to different units of measurement should contact Televac.

When the setpoint function is advanced to one of the setpoints "on" or "OFF" selection modes, the stored setpoint setting is converted to the selected unit, if different from the native unit. This then is the setpoint setting that is displayed. Changing this setting with the UP/DOWN arrows only affects the display. Upon leaving that function, the displayed value is converted to binary, then to the native unit for the sensor that corresponds, and is stored as such. At that moment the new value becomes the effective value for that setpoint. While adjusting "on" or "OFF" setpoints, it is not possible to change "UNITS".

When a unit other than the native unit is selected for display, a conversion will be made from the native unit to the selected unit before the display value is sent to the display buffer.

**503 3F HOT CATHODE MINI-BA MODULE (software ver. 2.31 or higher)**

With a hot cathode mini-BA installed in station 5 and when the setup button is pressed, the following appears on the display,

**3F (AUTO or SELF or BOTH)**

Use to up/dn arrow to change between the following,

**AUTO**

This means CC or BA is turned off by thermoconductivity gauge pressure reading only and comes back on when pressure falls below 10 microns

If CC or BA exceeds the range, reading should blink until overpressure is removed.

**SELF**

This means CC or BA is turned off by CC or BA overpressure only. The CC or BA must be reset by the front panel or by RS232.

**BOTH**

This means CC or BA is turned off by both the CC or BA overpressure and off and on by the thermoconductivity gauge pressure reading. If turned off by overpressure, the CC or BA must be reset by the front panel or by RS232.

Press the setup button again to advance to the following,

**FIL (ON or OFF or RDY)**

Use to up/dn arrow to turn the filament on or off.

Press the setup button again to advance to the following,

**(OFF or ON) DGAS**

Use to up/dn arrow to turn the degas on or off.

Press the setup button again to advance to the following,

(software ver. 2.31 or higher)

**(# time)DGAS**

If dgas is off then this selection will not appear, if dgas is on, a time in minutes can be selected. Use the up/dn arrow to select the time. If 0 is selected, the dgas remains on indefinitely.

Press the setup button again to advance to the following,

**FIL NBR (1 or 2)**

Use to up/dn arrow to turn the degas on or off.

Press the setup button again to advance to the following,

**(# sensitivity) SENS**

Use to up/dn arrow to set the sensitivity.

Press the setup button again to advance to the following,

If a hot cathode mini-BA is installed in station 5 and 6, the above setup will repeat for station 6.



## 600 COMMUNICATIONS

### 601 RS232 INTERFACING WITH COMPUTER USING MICROSOFT HYPER TERMINAL

1. Turn off the MM200, remove the module from slot #6 (if one is positioned in this slot) and install the RS232 module next to it, to the right. The modules must be installed at the same time.
2. Set the switch on the back of the RS232 module to setup.
3. Connect a RS232 extension cable from the back of the MM200 to your computer and turn the MM200 back on.
4. Verify the COM port the cable is connected to, in the control panel of your computer.
5. Open up the Hyper Terminal on your computer (click Start, Programs, Accessories, Communications, Hyper Terminal)
6. Double click Hyper Terminal icon (if you are already setup click on MM200 setup icon, verify that you are connected to the system, bottom left hand side of window should say connected, and proceed to step 11.)
7. Choose a name and an icon for future use. (This is what you will use after initial set up).
8. Click on the connect using tab and choose the COM port that you found in step 3. Click OK.
  - a. Set bits per second to 9600
  - b. Leave data bit, parity, and stop bits where they are set
  - c. Set flow control to Xon/Xoff.
  - d. Close configure box.
9. Verify that you are connected to system. (Bottom left hand side of window should say connected.)
10. Click properties on Hyper Terminal, far right icon on task bar.
  - a. Click on settings tab
  - b. Click on terminal keys
  - c. Click on Ctrl + H
  - d. Choose auto detect from emulation optics.
  - e. Set backscroll buffer lines to 500
  - f. Click on ASCII setup.
    - i. Click on: Append line feeds to incoming line ends.
    - ii. Click on: Wrap lines that exceed terminal width.
    - iii. Click OK to close ASCII box
  - g. Click OK to close properties box
11. Type ST (reads data) and press enter (this should list internal parameters for vacuum gauge.)
12. Find output scale you are looking for from the back of this sheet, type in corresponding code number and press enter. (an "A" will appear).
13. Type SE (Sets data) and press enter.
14. Repeat step 12 and confirm the change you made was accepted.
15. Close Hyper Terminal (save changes on first time setup).
16. Turn the MM200 off, remove the RS232 module (if desired), and disconnect the cable.
17. Setup is now complete.

**602 RS232/485 - FOR SOFTWARE VERSION 2.31 OR HIGHER**

The communications mode (RS232 / RS485) is now selected thru the front panel in setup. This is the last selection when scrolling thru setup. To go directly to the communications setup, press the setup button, then press the test/op button once. The following selection will appear,

**RS232 or RS485**

(use up/dn arrow to select)

Press setup button to advance to next selection or test/op to exit.

**STD or ALT (RS485 only)**

(use up/dn arrow to select)

Press setup button to advance to next selection or test/op to exit.

**UNIT #xx (RS485 and STD only)**

(use up/dn arrow to select)

Press setup button to advance to next selection or test/op to exit.

**PREF #xx (RS485 only)**

(use up/dn arrow to select)

Press setup or test/op to exit.

In **STD** mode , a prefix and address must be selected for each instrument on the bus. If the same prefix is selected for multiple instruments, then each of these must have a different address. A STD addressable command then consists of a prefix, address, and command. The number of addresses available for the standard RS485 mode are 59.

In **ALT** mode the prefix is used as the individual address. Each instrument on the bus would use a different prefix. This limits the number of slaves on a bus to 21. However, a unit on the bus would never be interrupted except when it is addressed. The master would send the prefix for the unit it intended to address followed by the command with no unit number required.



**RS485 PREFIX AND ADDRESSES TABLE - FOR SOFTWARE VERSION 2.31 OR HIGHER  
PREFIX**

SELECT	CHAR
1	"
2	#
3	\$
4	%
5	&
6	'
7	(
8	)
9	*
10	/
11	:
12	;
13	<
14	>
15	[
16	\
17	]
18	{
19	
20	}
21	~

**UNIT ADDRESSES**

SELECT	ADR	SELECT	ADR	SELECT	ADR
01	1	22	M	43	i
02	2	23	N	44	j
03	3	24	O	45	k
04	4	25	P	46	l
05	5	26	Q	47	m
06	6	27	R	48	n
07	7	28	S	49	o
08	8	29	T	50	p
09	9	30	U	51	q
10	A	31	V	52	r
11	B	32	W	53	s
12	C	33	Y	54	t
13	D	34	Z	55	u
14	E	35	a	56	v
15	F	36	b	57	w
16	G	37	c	58	y
17	H	38	d	59	z
18	I	39	e		
19	J	40	f		
20	K	41	g		
21	L	42	h		



### NEW COMMANDS FOR MM200 - FOR SOFTWARE VERSION 2.31 OR HIGHER

- EBH Cold Cathode station 6 to BOTH mode.
- EBL Cold Cathode station 5 to BOTH mode
- EHH Cold Cathode station 6 to AUTO mode.
- EHL Cold Cathode station 5 to AUTO mode.
- ESH Cold Cathode station 6 to SELF mode.
- ESL Cold Cathode station 5 to SELF mode.
- FFH Turn filament off for station 6, 3F gauge. The higher position of two possible 3F gauges.
- FFL Turn filament off for station 5, 3F gauge. The lower position of two possible 3F gauges.
- FH1 Switch to filament number 1 for station 6, 3F gauge.
- FH2 Switch to filament number 2 for station 6, 3F gauge.
- FL1 Switch to filament number 1 for station 5, 3F gauge.
- FL2 Switch to filament number 2 for station 5, 3F gauge.
- FNH Turn the filament on for station 6, 3F gauge. --not working yet--
- FNL Turn the filament on for station 5, 3F gauge.
- GFH Turn degas off for station 6, 3F gauge.
- GFL Turn degas off for station 5, 3F gauge.
- GNH Turn degas on for station 6, 3F gauge.
- GNL Turn degas on for station 5, 3F gauge.
- RO This command outputs the voltage being received from each of the sensor modules plus stations 8 and 9. Stations 8 and 9 are actually the filament drive being supplied to stations 5 and 6 when 3F gauge(s) are installed. This command can be used place of the SD command that is used with 3D or 3E gauges. Use CA command or X to stop.

### COMMANDS THAT HAVE BEEN UPDATED FOR 3F MODULES

- GTnnn Set degas time to nnn minutes. (must include lead zeroes) When time is set to zero, the degassing is untimed and must be ended manually through setup. In this case the two 3Fs can be individually timed (manually). When any other value is set both station 5 and/or station 6 will stop degassing when the time runs down to zero.
- Rx Read station x
- Sx Send station x process type.
- ST Send status.

### OTHER

- SD Send filament drive, use RO. Filament drive for station five is displayed as station 8, filament drive for station 6 is displayed as station 9. Use CA command or X to stop.



---

## COMMANDS FOR THE 3F HOT CATHODE MINI-BA MODULE

NOTE: When installing or removing a 3F HOT CATHODE MINI-BA MODULE from the MM200, these commands must be entered to enable or disable the 3F module. Also, the SE command should follow in order to save the entry. If one or two 3F modules are to be installed, enter the SA3 command. If no 3F modules are installed, enter the CA3 command.

SA3 – Command to enable 3F modules.

CA3 – Command to disable 3F modules.

---

The following commands have been deleted,

G2

G4

RR

## 603 COMMUNICATIONS

**RS232/RS485** The Televac Modular Vacuum Gage accepts various sensor modules and relay modules, as well as a communications module. Upon power-up, the microprocessor determines the actual configuration of the modular unit by way of electrical tests.

Aside from the front panel operation of the modular unit, there are over 100 commands that can be issued by way of the RS232 or RS485 interface (communications interface) to control the operation of the modular unit. Availability of the RS422 functions depends on having the proper communications board to handle RS422. The standard board handles RS232 and RS485.

The description of these commands is given below, followed by a summary. The commands are separated into groups, where in each group the commands relate to a common subject. For additional RS485 commands see "RS485 Host Command Set".

Note that in the following discussion, where quotation marks are used, they are neither a part of command nor part of the response. Also, the symbol "<cr>" refers to the sending of a carriage return (ODH), either in the command, or in the response. All commands will produce a response (except RS485 "broadcast" commands) so that the host will know that the command has been received.

If a command is not recognized as a legitimate command, the response will be a question mark "<cr>". Commands that do not require a response otherwise, will respond with "A<cr>" to indicate that the command has been received (acknowledged) and the required action has or will be taken.



Most "?<cr>" responses will be preceded by a letter indicating the reason for the rejection of the command. The following list gives the definitions of those letters:

- A Atmospheric correction only allowed for 4A gauges.
- C A non number was where a number should have been.
- D Disallowed, usually by the configuration of the unit.
- L Value inputted was too large.
- N Number not in range.
- O Input buffer overloaded.
- R Command not recognized.
- S Wrong sensor type.

The RS232 communication protocol requires eight bits of data, one start bit and one stop bit. The use of parity is optional. The parity bit, if used, occupies the eighth bit of data, so that depending on the communications software used, the data length may have to be changed to seven bits (as the parity bit is then added after the seventh bit).

The default data rate on a new unit is 9600 baud, but may be changed by way of the communications inter-face to 300, 600, 2400, 4800, or 9600 baud. The baud rate can be stored for default on power up. Alternate baud rates can be factory supplied.

A description of the various commands follows. They are separated into the different categories.

#### 604 RS232/RS485 COMMANDS

"BF<cr>"

1. Exit burst mode. This command causes the processor to exit the burst mode. See the next two commands for a description of the burst mode.

"BN<cr>"

2. Enter the burst mode. This command causes the processor to go into the burst mode. The burst mode provides a means to dump the readings of all processors in a compact and rapid manner while still in ASCII form. There are some restrictions on the use of the burst mode. If two relay modules are installed, (eight relays) then burst mode is not available. If one relay board is installed (four relays), then up to seven sensors can be accommodated. If no relay modules are installed, then a full complement of ten sensors can be accommodated. If only one relay module is installed, it must be designated as relay module #1.

This command can be stored so that at power up, the modular unit will be in the burst mode. Storing the "BF" command will cancel the storing of this command.

"BO<cr>"

3. Output data in the burst mode. This command causes an uninterrupted dump of the data of all installed sensors. The data is stored in RAM so there is no need to wait for any sensors to be measured for a response from this command.





The normal format of the data is four ASCII characters for each sensor starting with the lowest numbered station up to the highest numbered station in sequence. If a sensor is inactive for some reason, one or two letters are sent, instead of the four digits, to indicate the status of the sensor.

For all sensors the format is the same, three significant digits and an exponent. There is an implied decimal point between the first and second digits, and an implied sign for the exponent. The sign can be positive or negative depending upon the sensor. There are no delimiters in the data stream. If an exponent goes to ten an "A" will be sent for the exponent. For an exponent of eleven, a "B" will be sent.

If a resident 3D or 3E is present several special codes are used. If the 3D or 3E has been turned "OFF" via RS232, an "R" will be sent instead of the four digits. If it has been shut off due to going over range an "S" will be sent. If it is off due for any other reason an "F" will be sent.

"BRE<cr>"

4. Set to "burst" and RS485 with presets and "even" parity. This command presets several conditions and then goes to the RS485 mode. It is useful in applications where optimum conditions are required for rapid output of data from many sensors. It is equivalent to the following series of commands:

- "BE<cr>" Blank echo.
- "AD<cr>" Add delay of 2 milliseconds to RS485 response.
- "FI<cr>" Inhibit certain front panel operations.
- "CA<cr>" Cancel auto output of data.
- "EL<cr>" End leak rate test.
- "AT<cr>" Add time out to command bytes.
- "CP<cr>" Clear the password.
- "BN<cr>" Go to burst mode.
- "PE<cr>" Test and generate "even" parity.
- "G4<cr>" Go to RS485 interface.



"BRO<cr>"

5. Set to "burst" and RS485 and "odd" parity. This command is the same as "BRE<cr>" above except that "odd" parity is tested and generated.

These two commands can be sent via RS232. After sending them the RS232 should be disconnected (or disabled). Any further reception via the RS232 will have the same effect as receiving the following commands:

"EE<cr>" Enable echo.

"PF<cr>" Turn parity test and generation "off".

"RD<cr>" Remove the two millisecond delay.

"CT<cr>" Cancel the 50 millisecond command string timeout.

"G2<cr>" Go to RS232 interface.

Note: The first character received will usually not be properly received.

"SRE<cr>"

6. Set the default to RS485/Burst with "even" parity for power up only. This command sets up the same conditions as does the "BRE<cr>" command above without switching to those conditions until power is shut off and then is powered up again.

"SRO<cr>"

7. Set the default to RS485/Burst with "odd" parity for power up only. The same as "SRE" above, except "odd" parity.

"SRC<cr>"

8. Clear the defaults generated by "SRE" and "SRO". This allows the default power up condition to return to RS232.

## COLD CATHODE

"CAE<cr>". This command changes the mode of the C/C gauge with an even station number to "auto", provided that an appropriate T/C gauge is installed. In this

mode the gauge will only be turned "off" automatically by the associated T/C or other gauge reading over 10 microns.

"CAO<cr>".

This command changes the mode of the C/C gauge with an odd station number to "auto" provided that an appropriate T/C gauge is installed. (See above).

"CBE<cr>".

This command changes the mode of the C/C gauge with an even station number to "both" provided that an appropriate T/C gauge is installed. This mode will allow the C/C to be shut down by either pressure on the associated T/C or other gauge reading over 10 microns or its own pressure reading above 10 microns.



- "CBO<cr>". This command changes the mode of the C/C gauge with an odd station number to "both" provided that an appropriate T/C gauge is installed. (See above).
- "CCF<cr>". Turn cold cathode off.
- "CCN<cr>". Allows cold cathodes to turn on.
- "CFE<cr>". This command turns off the high voltage to the C/C gauge with an even station number. If this command is issued, the indications in the setup routine will be different from those described above. In the on/off portion of the setup routine, the display will show "r232" indicating that the gauge has been turned off via the serial port. Pressing the left hand up or down arrows will have the same effect as pressing the setup push button. If the gauge is turned off via the serial port, then it cannot be reset by the front panel, it can only be reset via the serial port. Had the "SE<cr>" command been issued, or if any changes been made to set point settings while having been shut down via the serial port, then this cannot be reset by turning the power off and back on.
- "CFO<cr>". This command is the same as the "CFE<cr>" command except that it applies to the C/C gauge with an odd station number.
- "CNE<cr>". This command turns on the gauge with an even station number. Note: It will not come on if in the "auto" mode or the "both" mode if turned off by the associated T/C gauge, but the display will show "rdy" instead of "on". Also, it might shut down again immediately if it is in the "self" mode or the "both" mode and the corresponding T/C gauge pressure is above the preset value.
- "CNO<cr>". The same as the "CNE<cr>" command, except that it applies to the C/C gauge with an odd station number.
- "CPF<cr>". Cold cathodes are off at power up.
- "CPN<cr>". Cold cathodes as previous at power up.
- "CSE<cr>". This command changes the mode of the C/C gauge with an even station number to "self". The C/C gauge will turn "off" automatically only when its own pressure reading exceeds 10 microns.
- "CSO<cr>". This command changes the mode of the C/C gauge with an odd station number to "self". (See above).

**COMMUNICATIONS**

(See also "BRE", "BRO", "SRE", and "SRO" above under "Burst" commands).

All of these commands can be stored so that they will be in effect at power up.

"AD<cr>"

1. Add delay for RS485 operation. This command adds a slight delay to the initial response to any RS485 command. It is required for proper operation when the RS485 communications hardware of the host cannot handle the immediate response that the MM200 is capable of providing. Some converters such as the B & B model 485TBLED, when using the transmitted signal to control the direction of the signal, are not ready to accept a response as quickly as the Modular Unit responds, causes contention and signal garbling.

"BE<cr>"

2. Blank the echo. This command causes the modular unit not to echo commands. However, the appropriate responses to the commands will still be given.

"AT<cr>".

3. Add command input timeout. This command causes a 50 millisecond time out to be inserted when receiving a command string. If there is a delay of 50 milliseconds or more between any two bytes of a command string, the received portion of the command will be ignored. The input buffer will be reset and ready to receive a new command (or RS485 address).

"CT<cr>"

4. Cancel the command input time out. (See "AT<cr>" above).

"EE<cr>"

5. Enable the echoing of the command characters. This command causes all command characters to be echoed to the host. This is the default setting for a new unit. It can be stored, in which case the stored "BE" command is canceled. Echoed commands are very useful when someone is checking out or operating the unit from a dumb terminal, or a PC with communications software.

"G2<cr>"

6. Go to the RS422 mode. This mode is identical to the RS232 mode, except that communications is through the RS422/RS485 port. There will be no response on RS232. If any additional characters are sent via RS232 the mode will revert to RS 232.

"G4<cr>"

7. Go to the RS485 mode. This command causes the modular unit to go into the RS485 mode. See "RS485 HOST COMMAND SET". There will be no response on RS232. If any additional characters are sent via RS232 the mode will revert to RS 232.



"PE&lt;cr&gt;"

8. Insert and test for even parity. This command causes the modular unit to insert, as required, in the eighth data bit location, a bit to cause the parity to be even (an even number of one bits). The modular unit also tests to see if

the received characters have even parity, if not, the modular unit sends an exclamation mark "!" before the next character that it sends. If the command string had been blanked by the "BE" command, the parity error could have occurred anywhere in the command string. Note that, even when there is a parity error detected, if the command is intelligible, the modular unit responds in the normal manner, except for the inclusion of the exclamation mark. In RS485 operation, the command will be ignored if a parity error occurs in the command.

"PF&lt;cr&gt;"

9. Turn OFF the parity check. This command cancels parity check and insertion for type of parity. This is the normal default mode for the modular unit.

"PO&lt;cr&gt;"

10. Insert and test for odd parity. This is the same as "PE" above, except for odd parity. (An odd number of 1 bits).

RD&lt;cr&gt;"

11. Remove RS485 delay . This command removes the initial RS485 delay, if it had been inserted by the "AD<cr>" command.

12. Return to RS232 (from RS422 or RS485) "RR<cr>".

SBII&lt;cr&gt;

13. Set the baud rate. This allows the operator to change the baud rate. "II" is a letter that is repeated for redundancy sake. The baud rate changes according to the following table:

AA	300 baud
BB	600 "
CC	1200 "
DD	2400 "
EE	4800 "
FF	9600 "

The modular unit responds with "A<cr>" prior to changing it's baud rate. Any further communications must be performed at the new baud rate.

"EAx&lt;cr&gt;"

14. Enter the RS485 address. This command allows entering an address code byte (ASCII) from the table given in "RS485 Host Command Set". These code bytes are case sensitive, and can be stored for use at power up.



"RA<cr>"

15. Read the RS485 address code. The unit responds with the code byte (ASCII) that is the RS485 address of the unit.

"SE<cr>"

16. Store default values. This command causes all designated storable data to be stored in the EEPROM, so that they will be in effect at power up.

When the baud rate is changed by the "SBII" command, the "SE" command should be given at the new baud rate, if it is desired for the modular unit to be at the new baud rate after power has been removed and re-applied. It should be noted that if the display units or any other storable items had been changed prior to using this command, then such changes will be in effect the next time that power is applied. The response to this command is "A<cr>".

## CONFIGURATION

The configuration of the Modular unit (i.e. how many relays and types of sensors that are plugged in and what their assignments are) can be determined through the use of several commands.

"AR<cr>"

1. Send the relay configuration. The modular unit will respond with the relay configuration in one of these formats:

"RY=0,0" "RY=1,0" "RY=0,2" or "RY=1,2" depending on which relay modules are inserted. Each relay module contains four relays. These are referred to as PCR1, PCR2, ....etc. The first module, if installed, provides relays PCR1 through PCR4. A second module, if installed, provides relays PCR5 through PCR8. If the burst mode is to be used, and a single relay board is installed, it must be installed as relay board #1.

In the burst mode, the response is "0" for no relay modules, "1" is for relay module #1 only, "2" is for relay module #2 only (a condition that should not exist), and "3" for both relay modules.



"SC<cr>"

2. Send all processor types. This causes the processor types for all ten stations to be dumped. They are sent in a string of ten digits (or letters). The first digit or letter corresponds to station #1, and so forth.

The digits or letter that corresponds to the sensor types are:

SENSOR TYPE	
0	none installed
1	7F Extra wide range CC
2	3E E-Beam degas HC
3	2A Thermocouple
4	4A Convection gauge
5	1F 10 bar diaphragm
6	1E 1000 Torr diaphragm
7	3D I-sqrd-R degas HC
8	7B Standard CC
9	5A 1000 Torr Capacitance Diaphragm Gauge
A	7E Wide range CC
B	5D 1000 micron Capacitance Diaphragm Gauge
C	5B 100 Torr capacitance Diaphragm Gauge
D	5C 10 Torr Capacitance Diaphragm Gauge
E	5E 10 micron Capacitance Diaphragm Gauge
F	5F 10,000 Torr Capacitance Diaphragm Gauge or other special option

A "0" means that there is no sensor assigned to this station.

If a hot cathode model 3D, or 3E is installed, then only five digits, or letters will be sent, and the hot cathode gauge will always occupy station number five. If a cold cathode is installed then only 9 digits will be sent.

"Sx<cr>"

3. Send processor type for a station. The modular unit responds with the sensor type that is installed in station "x". For example if "S1<cr>" were sent, and station number 1 contained a Model 2A thermocouple module, the response would be "S1=2A<cr>". If station 1 were not occupied, the response would be "S2=none<cr>". In the burst mode, the number or letter indicated in 2 above will be sent.

"SV<cr>"

4. Fetch the modular unit software version. The modular unit responds with "Ver n.nn<cr>", where n.nn is the version number.



## DATA OUTPUT

"Annn<cr>"

1. Automatically output periodic readings from any selected number of the sensors. Where "nnn" determines the rate at which data is outputted and is any number from 001 to 255. Note that three digits must be sent including lead zeros. All marked stations (see below) shall have their readings output at the end of "nnn" loops of measuring all the station that are installed. The time between outputs is approximately  $0.11 * nnn * (\text{the number of stations that are installed in the modular unit, no matter how many stations are having their data outputted})$ . This feature is not available in the burst mode.

The data output is in the same format as for the "Rx<cr>" command below, except that where more than one station is outputted, the outputs are separated by spaces. The last (marked) station value output is followed by a carriage return. For example if eight stations are installed, stations 1, 4, and 7 are marked, and the command "A010<cr>" is sent.

Approximately every 8.8 seconds the modular unit would output something like:

"1=1.23+3U 4=4.50+1U 7=1.10-5T<cr>"

"BO<cr>"

2. Output data in the burst mode. This command causes an uninterrupted dump of the data of all installed sensors. The data is stored in RAM so there is no need to wait for any sensors to be measured for a response from this command.

The normal format of the data is four ASCII characters for each sensor starting with the lowest numbered station up to the highest numbered station in sequence. If a sensor is inactive for some reason, one or two letters are sent, instead of the four digits, to indicate the status of the sensor.

For all sensors the format is the same, three significant digits and an exponent. There is an implied decimal point between the first and second digits, and an implied sign for the exponent. The sign can be positive or negative depending upon the sensor. There are no delimiters in the data stream. If an exponent goes to ten an "A" will be sent for the exponent. For an exponent of eleven, a "B" will be sent.

If a resident 3D or 3E is present several special codes are used. If the 3D or 3E has been turned "OFF" via RS232, an "R" will be sent instead of the four digits. If it has been shut off due to going over





range an "S" will be sent. If it is off due for any other reason an "F" will be sent.

"CA<cr>"

3. Cancel automatic output of data. This command causes the automatic output of data to cease. It does not "unmark" stations, they stay marked, and if the "Annn<cr>" command is again given, the output of data from those stations that had been marked will resume. The response to this command is "A<cr>".

"Mx<cr>"

4. Mark the stations from which the above automatic readings shall be received. Where x is the number of the station to be "marked" for automatic output (mark one station at a time). The response to this command is "A<cr>".

"Rx<cr>"

5. Obtain individual vacuum readings from the various sensors. Where x is the station from which a reading is desired. To read station number 10, R0<cr> must be sent.

The response to this command, when not in the burst mode, is in the same format for all types of sensors. That is, the response is in exponential form. The form is "n=x.xx(+ or -)yu", where "n" is the station number, "x.xx" is the value given to two decimal places, followed by either a plus or a minus, followed by the exponent (power of ten), followed by either a "U" for microns or a "T" for Torr. For example, a Model 2A thermocouple at station #2 might respond "2=2.45+2U", corresponding to a pressure reading of 245 microns. Note that station number 10 will be designated by "A=...". This command should not be used at the same time that the "Annn<cr>" command is being used, and none of the stations should be marked for automatic output when this command is used. The units remain Torr or microns regardless of the units chosen for front panel display.

When in the "burst" mode, the response is the same as given above for the "BO<cr>". The burst mode cancels automatic output of data for stations.

When in the "Burst" mode, a C/C gauge will give the following responses:

- A. If the gauge is active, the output will be four characters. The first is the whole value digit, followed by an implied decimal point, followed by the next two significant digits. There is then an implied "-" sign followed by the exponent. For an exponent of "-10" an "A" is sent. For an exponent of "-11", a "B" is sent.



- B. If the gauge is not active or if the value being measured is below the range of the instrument, two letters are sent. The first letter corresponds to the mode of operation. An "S" is sent for the "self" mode, An "A" for the "auto" mode and a "B" for the "both" mode. If the gauge is inactive due to a command via the serial port, these letters will be lower case.

The second letter indicates the status of control of the gauge as follows:

"A" indicates that in the "auto" mode or the "both" mode, the gauge had been deactivated by the associated T/C gauge.

"B" indicates that the gauge is active but is measuring pressure that is below its range.

"F" indicates that the gauge has been turned off from the front panel, or has not been turned on since being powered up.

"S" indicates that in either the "self" mode or in the "both" mode, the maximum range had been exceeded, and the gauge shut itself down.

"S" indicates that in either the "self" mode or in the "both" mode, the maximum range had been exceeded, and the gauge shut itself down.

"Ux<cr>"

- 6. Unmark stations. This command removes stations from automatically having their data outputted. All marked stations should be unmarked with this command prior to using the "Rx<cr>" command (above). The response to this command is "A<cr>".

**DISPLAY**

"DLx<cr>"

- 1. Change the stations being displayed on the front panel in the left hand display. This causes the left hand display-to-display station "x".

"DRx<cr>"

- 2. Change the station being displayed on the front panel right hand display. This causes the right hand display-to-display station "x".

Both of these functions can be overridden by a local operator. The response to these commands is "A<cr>". Note that changing stations being displayed has no effect on the operation of the unit.



- "FA<cr>" 3. Inhibit certain push button functions. It inhibits going into setup, going into leak-rate, and changing calibration to "gas". The operator can still change the stations that are being displayed.
- "FE<cr>" 4. Enable a local operator to make the changes inhibited by the "FA", and "FI" commands. Except that the local operator will not be able to make these changes if the rear panel inhibit switch is activated (see "FI" command). The response is "A<cr>".
- "FI<cr>" 5. Inhibit certain push button operations. This command has the same effect as operating the rear panel key switch. The operator cannot change units, cannot change calibration to "gas" and cannot change setpoint assignments, and settings.
6. Change the "Units" in which the Modular unit is displaying readings. There are three separate commands for this function:
- "UM<cr>" Causes both displays to display in millibars.
- "UP<cr>" Causes both displays to display in Pascals.
- "UT<cr>" Causes stations to be displayed in Televac traditional units. For example a cold cathode station would be displayed in Torr, a thermocouple or convection sensor would be displayed in either Torr or microns, depending upon the magnitude of the pressure. The response in all three cases is "A<cr>".
- "D1E<cr>" 7. Display 1F diaphragm gauges in exponential form. 1F gauges cover the range from zero to 10 bars. When being displayed, the mBAR light is lit. When this command is invoked, the display shows two digits separated by a decimal point, followed by "E3". This puts the digits directly in "bars". This command can be stored by the "SE<cr>" command, or will be stored whenever set points are changed.
- "D1L<cr>" 8. Display 1F diaphragm gauges in linear form.  
This causes 1F diaphragm gauges to be displayed in linear form in millibars. The resolution is then consistent with other linear displays.
- GAS** (Argon, etc.)
- "GFx<cr>" 1. Remove a station from "Gas" operation. The "x" is the station number of the station being removed from operation with "Gas". The operation is the reverse of "GNx<cr>" below. The response to this command is "A<cr>".



"GNx<cr>"

2. Assign a station to operate with Gas. Where "x" is the station to be switched to have it's response calibrated for gas. This command is not allowed in the "burst" mode. This command is different from assigning "Gas" from the front panel in that it does not matter if the station is being displayed. In order for a station to be selected for "Gas" operation by way of the front panel push button, the station must be being displayed in the right hand display. The response to this command is "A<cr>".

## HOT CATHODE

"AH<cr>"

1. Go to the AUTO mode. The command causes the resident hot cathode gauge to be controlled by the thermocouple or convection gauge that has the lowest station number.

By control is meant, when the pressure of the controlling sensor exceeds 3 microns for uncoated tubes or 10 microns for coated tubes, the hot cathode filament will shut off (as well as degas, had that been ON). The filament only will come back on when the pressure of the controlling

ON.

"EH<cr>"

2. Go to the SELF-mode. This takes the hot cathode gauge out of the AUTO mode or out of the OFF mode and allows it to shut itself down by virtue of it reading a pressure above it's normal range. This command does not turn the filament on. Initially or when the filament shuts down, it must be restarted either through the front panel push button, or through the RS232 "FN<cr>" command.

"EB<cr>"

3. Go to the "BOTH" mode. This enables the hot cathode gauge to be turned off by either of the above events. When turned off by it's own reading being too high, then it can only be turned on by operating the front panel set up functions, or by way of the RS232 interface.

"FF<cr>"

4. Turn the hot cathode filament OFF. This command turns off the filament of the hot cathode gauge. The filament cannot be turned on neither through the front panel controls, nor through the control of it's associated thermocouple or convection gauge.

"FN<cr>"

5. Turn the hot cathode filament ON. This command is like the front panel selection of filament ready ("rdy"). If the HC gauge is in the "AUTO" mode, the filament will go on if the pressure at the associated sensor is below the turn off value, otherwise it will wait until the pressure is low enough.

"FNn<cr>"

6. Select filament #1 or #2. Where "n" is the filament number.



- "GF<cr>" 7. Turn the 3D or 3E degas OFF. This command stops the degas function if it is active. This does not inhibit setting up degas via the front panel. This and the broadcast "Q" command are the only ways that the degas can be halted, if it was started by the "GN<cr>" command. Of course any thing that turns the filament off will also turn off degas, including power down. If the filament is restarted, the degas will not automatically be restarted.
- "GN<cr>" 8. Turn the 3D or 3E degas ON. This command turns the 3D or 3E degas on for an indefinite period of time. To shut degas off, the "GF" command or the broadcast command "Q" must be used. The filament must be on for this command to take effect. Shutting the filament off by any means will also shut off degas (see "GF" command).
- "GNxxx<cr>" 9. Turn the degas on for a specified period of time. This will turn on the degas for "xxx" minutes, where "xxx" is anywhere from 001 to 255. Three digits must be sent including lead zeros, if any. The front panel will flash the de-gas time the same as if it were set from the front panel, except that while the de-gas time is over 99 minutes, the display will flash "dG--".
- "E2<cr>" 10. Observe the 24 volt enable input for filament operation. After this command has been issued, the filament of either, a 3D or 3E will not communications board.
- "C2<cr>" 11. Cancel use of the 24-volt enable signal for filament operation. This cancels the "E2" command. These two commands can be stored to be in effect at power up.
- "RS<cr>" 12. Read switch position. Response "0" thru "7".
- "SWx<cr>" 13. Logically set the rear panel 3D or 3E tube type selector switch. This makes the modular unit respond as if the rear panel switch were set to "x". (Of course, the switch physically remains as it was). The results of this test cannot be stored.

## LEAK RATE

- "ED<cr>" 1. End Leak Rate data output. This command halts the output of leak rate data to the communications interface, but does not stop the leak rate test. It can be used when it is desired to momentarily interrupt the data flow, without interrupting the test itself, so that other commands could be exercised. The front panel continues to display the leak rate test results. The response to this command is "A<cr>".



- "EL<cr>"                    2. End the leak rate test. This command causes the leak rate test to cease, the same as the front panel push button would do if pressed while the leak rate test is in progress. The response to this command is "A<cr>".
- "LR<cr>"                    3. Initiate Leak Rate testing. The results are the same as pressing the front panel "leak rate" push button. Whenever this command is issued the leak rate test starts at time "zero". This command can be used for resetting the test time to "zero", if the test is already in progress. The front panel display responds the same as if the front panel push button had been pressed, that is, the right hand display shows the leak rate values. It differs in that if the unit is in the leak rate test, pressing the front panel push button will toggle the leak rate test off. The response to this command is "A<cr>". Leak rate tests always use station #1 as the sensor, and displays in the right hand window.
- "RL<cr>"                    4. Periodically obtain Leak Rate readings. This command causes the modular unit to periodically output the leak rate reading. The data is in the form of four digits, which include any lead zeros, followed by a carriage return such as "0015<cr>". The four digits give the leak rate in microns per hour (the same as displayed on the front panel). The data is outputted once every second. The initial response to this command is "A<cr>".

None of the leak rate functions above are available when in the burst mode. If any are in effect upon entering the burst mode, they are cancelled.

## OUTPUTS

- "RF<cr>"                    1. Disable Recorder Outputs. This command disables the recorder outputs. This provides a slight reduction of response time when in the "burst" mode. The voltage at the recorder output terminals are then undetermined.
- "RN<cr>"                    2. Enable Recorder Outputs. This command restores the recorder outputs to normal.
- "Rssf<cr>"                    3. Set recorder output of a particular type sensor to a particular format. Where "ss" is the sensor type and "f" is the format. See the list under "Command Summary" for available formats.

## SET POINTS

- "CPn<cr>"                    Clear setpoint values for relay "n".
- "PCA<cr>"                    1. Control all relays via the communications interface. In order for a relay to be controlled via the communications interface, its contro



must first be passed over to that interface. This is to prevent confusion between being turned on or off by the assigned sensor or by the communications interface. This command passes the control of all relays to the communications interface simultaneously.

- "PCn<cr>" 2. Assign the control of one relay to the communications interface. Where "n" is the relay number. The same as above except the control of just relay #"n" is passed.
- "PFn<cr>" 3. De-energize a particular relay via the communications interface. Where "n" is the relay number. The relay must first be assigned to be controlled via the communication interface by either the "PCA" command or the "PCn" command.
- "PNn<cr>" 4. Energize a particular relay via the communications interface. As (3) above, except that it energizes the relay.
- "PUA<cr>" 5. Remove all relays from control by the communications interface. This is the reverse of the "PCA" command.
- "PUn<cr>" 6. Remove a single relay from control via the communications interface. Where "n" is the relay number being removed from control via the communications interface. Control of this relay then reverts to whatever sensor it had been assigned to.
- "SAxSy<cr>" 7. Assign a particular relay to a particular sensor. This assigns control of relay "x" to station "y". The response to this command is "A<cr>". If stored, this will then be the default station at power-up.
- NOTE: PCR setting for any such reassigned PCRs must be reset unless both stations have the same sensor type.
- "SPx<cr>" 8. Send the station assignment of a particular station. This causes the modular unit to respond with the station number assigned to relay "x" followed by a "<cr>".
- "SPxN<cr>" 9. Send the ON setting of a particular relay. This causes the modular unit to respond with the ON set point setting of relay "x". The response to this command is a four digit number including lead zeros followed by a "<cr>". The format of the response is the same as for the "SSxFyyyu" or the "SSxFy.y-n" command below.
- "SPxF<cr>" 10. Send the OFF setting of a particular relay. This causes the modular unit to respond with the OFF set point setting of relay "x". The response to this command is a four digit number followed by a "<cr>". The format is the same as for the "SSxFyyyu" or the "SSxFy.y-n" command below.



"SSxFyyyyu<cr>"

11. Set the OFF set point of a particular relay. Where "x" is the relay number for which it is desired to set the dropout (de-energize) point, and "nnnn" is the setting. The response to this command is "A<cr>". See the chart below for ranges of settings for various sensors.

"SSxNyyyyyu<cr>"

12. Set the ON set point of a particular relay. Where "x" is the relay number, and "nnnn" is the setting. See the chart below for ranges of settings for the various sensors.

"SSxFy.y-n<cr>"

13. Set the OFF set point of a particular relay. Where "x" is the relay number for which it is desired to set the dropout (de-energize) point, and "y.y-n" is the exponential setting. The response to this command is "A<cr>". See the chart below for ranges of settings for various sensors.

"SSxNy.y-n<cr>"

14. Set the ON set point of a particular relay. Where "x" is the relay number, and "y.y-n" is the exponential setting. See the chart below for ranges of settings for the various sensors.





**SET POINT SETTING VALUES**

SENSOR	UNITS	RANGE	SETTING
1E	TORR	1-1000	0001H to 0999H
1F	TORR	0.1e3 to 9.9e3	0010 to 0990
2A	MICRONS	0-1000	0001L to 0999L
	TORR	1.0-20.0	0010H to 0200H
3D,3E,7F	TORR	0.0e-11 to 9.9e-2	0.0-B to 9.9-2
4A	MICRONS	1-1000	0001L to 0999L
	TORR	1-1000	0001H to 0999H
7B	TORR	1e-6 to 1.0e-3	0001L to 0990L
7E	TORR	1.0e-8 to 9.9e-6	0001L to 0990L
	TORR	1.0e-5 to 9.9e-3	0001H to 0990H
		008000	(not used)
		010000	Sensor #1 zero out of range
		020000	Sensor #2 zero out of range
		040000	Sensor #3 zero out of range
		080000	Sensor #4 zero out of range
		100000	Sensor #5 zero out of range
		200000	Sensor #6 zero out of range
	400000	Sensor #7 zero out of range	
	800000	Sensor #8 zero out of range	

"RY<cr>"

5. Send relay status. The response to this command is two characters followed by a <cr>. The first character corresponds to relay board #2 (PCR2). The second corresponds to relay board #1 (PCR1). If either board is not installed a lower case "n" is sent for it's character, otherwise an ASCII character is sent. The character is interpreted as a hex value where each of the bits is a "one" if the corresponding relay is energized, or a "zero" otherwise. For example: a response of "nC<cr>" would indicate that relay module number two (2) is not installed, and that relays #3 and #4 are operated. "C" hex = 1100.

"ST<cr>"

6. The status command. The "ST<cr>" command provides a quick look at the status of the modular unit. An example of using this command is:



```

ST
AUTO-OUT MODE OFF  DISPLAY UNITS TRAD
CAL VALUE=52960  GROUND COUNT=0110
FILAMENT IS OFF  FIL NUMBER 1
DE-GAS IS OFF  HOT CATH MODE - AUTO
HC/CC CONTROL STATIONS ODD/EVEN 1, 2
LEAK RATE OFF  STACK MARGIN = 16
RECORDER OUTPUT ON  RS232 SET PTS 00000000
PARITY IS NONE  SET PTS 1011
RELAY MODULES 1, 0  RECORDER FORMATS:
1E & 1F = LINEAR; 2A = LIN 0-1000U;
3D & 3E = LIN BY DECADE; 4A = LIN BY DECADE;
5A, 5C, 5D, = LINEAR; 7B = LIN BY DECADE;
7E & 7F = LIN BY DECADE
STATIONS 1=2A 2=2A 3=4A 4=4A 5=no 6=no
7=no 8=no 9=no 10=no
RS485 ADDRS 0  SW Ver 1.36
24 VOLT ENABLE OFF  24 VOLT SIG OFF
WATCH DOG IS ON  ZERO MODE OFF
1Z 000 2Z 000 2A 000 3Z 000 3A 000 4Z 000
4A 000 0000000

```

The interpretation of the various responses is as follows:

**A. "AUTO-OUT MODE (ON or OFF)".** This refers to automatic output of data from selected stations, in response to the mark command "Mx<cr>", and the "Axxx<cr>" command.

**B. "DISPLAY UNITS (PASCAL or mBAR or TRAD)".** This refers to the pressure units used by the display, which if "TRAD" then the display will be in the units that are standard for the particular sensor, which will normally be either Torr or Microns.

**C. "CAL VALUE=nnnnn".** "nnnnn" is a value that should be between 45000 and 62000. It is a number that is used by the software to calibrate the A/D converter to provide a precise relationship between the voltage and the output count. This is a variable that can change slightly whenever a calibration of the A/D converter occurs. The A/D converter is calibrated at power-up, whenever diagnostics are called for, and is automatically performed periodically while the unit is in operation. A variation outside of the normal range could indicate deterioration of the A/D converter, or possibly the voltage reference.

**D. "GROUND COUNT=nnnn".** The A/D converter is given a slight offset at the zero voltage end. This is done to prevent any slight actual offset in the converter from causing an error in measurements. Whenever calibration is performed, this offset is measured by measuring the counts obtained when the input of the A/D converter is connected to ground. This count is normally around 127, and may vary slightly with each calibration. A large variation of this value could indicate a deterioration of the A/D converter.

**E. "FILAMENT (ON or OFF)".** This refers to model 3D or 3E gauge filament status.



- F. **"FIL NUMBER (1 or 2)"**. This applies to the selection of filament only for the model 3D or 3E gauges.
- G. **"DE-GAS (ON or OFF)"**. This applies to de-gassing of either 3D or 3E model gauges.
- H. **"HOT CATHODE MODE (AUTO or SELF or BOTH)"**. This refers to the mode of operation that causes the filament of either model 3D or 3E to turn off automatically. "AUTO" means that the controlling thermocouple station will cause the filament to go off when a predetermined pressure is reached in the chamber. "SELF" means that when the pressure measured by the 3D or 3E sensor reaches a predetermined point the filament will shut off. "BOTH" means that either of these conditions will cause the filament to shut off.
- I. **"HC/CC CONTROL STATIONS ODD/EVEN (y, z)"**. At initialization, the station configuration is determined by the microprocessor starting at station #1 and proceeding in an increasing direction. The first T/C or convection type gauge sensed, "y", is assigned to control H/C and C/C gauges that are assigned odd station numbers. The next T/C or convection type gauge detected, "z", is assigned to control the H/C and C/C gauges that are assigned even station numbers.
- J. **"LEAK RATE (ON or OFF)"**. This shows if Leak Rate testing is in progress.
- K. **"PROC MARGIN = nn"**. This indicates how much microprocessor stack space has not been used since power was turned on. This is an indication of possible problems with the software. This number should not go to less than 3.
- L. **"0-10V OUTPUT (ON or OFF)"**. This indicates whether the recorder outputs have been disabled or not. Disabling them, if not being used, will result in a slight improvement of the response time in the "burst" mode.
- M. **"RS232 SET POINTS bbbbbbb"**. This indicates the set point relays that are under control of RS232. It does not indicate if they are operated or not. Each "b" is a bit indicated by a "1" or a "0". A "1" indicates that relay is under RS232 control. The left hand bit corresponds to relay #1, and so forth.
- N. **"PARITY IS (EVEN or ODD or NONE)"**. This indicates the parity mode that has been select for the modular unit.
- O. **"SET POINTS bbbbbbb"**. This indicates the operation of the set point relays regardless of whether they are locally or remotely controlled. If relay module RY2 is not installed, then there are only four bits. The left-hand bit corresponds to PCR1, and so forth.



- P. "RELAY MODULES (0 or 1), (0 or 2)". This indicates which relay modules, 1 and/or 2 are installed.
- Q. "RECORDER FORMATS": The existing selected recorder formats are indicated for all types of sensors whether or not those sensors are installed. The format is described in easily understood English.
- When the range of the sensor does not exceed three decades, this is usually linear. When the range of the sensor is four or more decades, the standard output is linear by the decade.
- R. "STATIONS 1=(type) 2=(type) (and so forth)". This spells out the type of sensor assigned to each station. If none are assigned, the response is "no", if a station failed to be properly identified during initialization then the response is "BAD". If a hot cathode gauge is installed, then only the first five stations will be outputted, otherwise all ten will be outputted.
- S. "RS485 ADDRS 'n' or 'l'". This indicates the assigned RS485 address, which may be a number or a letter. This address is case sensitive.
- T. "SW Ver n.nn". This is the installed software version.
- U. "24 VOLT ENABLE (ON or OFF)". This indicates whether control of model 3D or 3E gauge filament control has been enabled by the software. If so then the filaments cannot be turned on unless the 24 volt signal is available at the back panel.
- V. "24 VOLT SIGNAL (ON or OFF or N/A)." If the twenty-four volt input is enabled, this output will indicate whether the 24 volts is applied or not. If not enabled, this will be a N/A regardless of whether or not the 24 volts is applied.
- W. "WATCH DOG (ON or OFF)." This indicates whether the watch dog is active or not. It should always be active in normal operation.
- X. "ZERO MODE (ON or OFF or AUTO)". This indicates the mode of zero operation selected for certain types of gauges.
- Y. The next line contains the zero and ATMOS offset values for the first eight stations (whether applicable or not. (See the "OZ<cr>" command in "Thermocouple, Convection, and Diaphragm Gauges" below).
- Z. The next line (or two, if required) will indicate any faults that might be stored in RAM. (See the "DP<cr>" command above).



### CONVECTION GAUGE 4A ATMOSPHERE ADJUSTMENT

- "AF<cr>" 1. This turns off adjustment for atmosphere without disturbing the correction values that are presently in memory.
- "AN<cr>" 2. This turns on adjustment for atmosphere using whatever the values that are currently in memory.
- "AP<cr>" 3. This presets the memory values to neutral. The unit will respond as if the Atmosphere adjustment did not exist, whether the Atmosphere adjust was on or off. It does not turn "off" atmosphere adjustment (see "AF<cr>").
- "Ayxxx<cr>" 4. This command is used to perform an atmosphere adjustment. "y" is the station number, and "xxx" is the atmospheric pressure. This should be the true absolute pressure at the sensor. That is, it should not be the barometric pressure adjusted for sea level (as is commonly used for weather and aircraft).

### ZEROING THERMOCOUPLE, CONVECTION, AND DIAPHRAGM GAUGES

- "Zn<cr>" 1. Set the zero for a station. This command determines and stores an offset value for zeroing of station "n". It may be used with thermocouple, convection, capacitance manometer, or diaphragm gauges. It should only be used when the pressure at the gauge is known to be less than one tenth of the lowest possible reading of that gauge. It can be used with the first eight stations. For station number "n" an offset is determined so that the gauge will indicate zero when the "ZN" command (see below) is given, or will immediately zero if the modular unit is already in the "zero" mode.

If the reading is outside of a relatively small range of readings, a fault bit is set, and the maximum available correction is made. Should a subsequent attempt be made to zero the gauge, and the reading is within the proper range, an offset will be generated and applied. However, the fault bit will remain set. In this manner the host will be able to determine that a fault had occurred (even though it may have been in the operating procedure). The host can clear the error bit, re-zero at the known proper pressure, and determine if the fault occurs again. If it does, the sensor is likely at fault.



This command will respond with an "A<cr>", provided that "n" is in the range of "1" to "8", otherwise it will respond with a "?<cr>". This command can be used whether in the "zero" mode or not. If not in the zero mode, the offset will be stored for use in the zero mode. That is, the reading will not be affected if this command is issued while the gauge is not in the zero mode, however, the appropriate offset will be stored.

- "ZN<cr>"                    2. Enable zeroing of sensors. This command allows using the offset determined by application of the "Zn" command, to cancel zero offsets of all applicable sensors. This command responds with "A<cr>".
- "ZF<cr>"                    3. Disable zeroing of sensors. This command cancels the "ZN" command, and therefore stops zeroing. It does not affect the offsets previously determined. It also cancels the "ZA" auto zero command, if it is in effect. The "ZN" command may be re-issued in order to return to zeroing with the stored offsets. This command responds with "A<cr>".
- "ZA<cr>"                    4. Turn ON auto zeroing of sensors. This command is effective only while in the zeroing mode. This allows the sensors to correct for any negative readings, by determining an offset that cancels any such negative measurement. The offset, if generated, replaces the offset determined by the "Zn" command, and will remain as the offset until changed either by the "Zn" command, or the "ZC" clear command. This command responds with "A<cr>" only if in the zeroing mode, otherwise it responds with "D?<cr>".
- "ZO<cr>"                    5. Turn OFF auto zeroing of sensors. This command cancels the "ZA" command, so that no more auto zeroing will occur. The gauge remains in the zero mode, so that gauges will continue to be zeroed with whatever offsets are stored. Note however, that the offset that had been determined during auto zeroing will remain as the offset in effect for zeroing. This command responds with "A<cr>".
- "ZC<cr>"                    6. Reset stored offsets to zero. This command clears all offset values. Note however, that if in the auto zero mode, and there is a negative offset at a particular station, that offset will be automatically replaced zero mode, no offsets will be applied, and gauges will indicate their normal readings.
- "OZ<cr>"                    7. Output zeroing information. This command is not available in the burst mode. This command will cause the modular unit to output the zero values of the first eight sensors, followed by eight bits



containing bits that correspond to any zeros that were out of range of the zeroing commands. The range of values is from -90 to 165. The range of values for atmosphere adjustment is from -127 to +127. The displayed values are separated by spaces.

The data corresponds to the location of gauges that are serviced starting at the lowest station number. Each 4A type sensor uses two data locations. The first is for the "zero" offset adjustment, while the second data location is for the atmospheric adjustment value.

Each 1E, 1F, 2A, 5A, 5B, or 5C require only one data location, and that's for the "zero" adjustment.

The data positions are automatically assigned based upon the configuration of the unit. For example if stations #1 and #2 have 4A sensors, then the first location will be for the "zero" of station #1, the second location will be for the atmosphere adjustment of station #1, the third location will be for the "zero" adjustment of station #2, and the fourth location will be for the atmosphere adjustment of station #2. Then if stations #3 and #4 have 2A sensors, the fifth location would be for the "zero" of station #3, and the sixth location would be for the "zero" of station #4 (since the 2A sensor does not allow for an atmosphere adjustment).

In the above example, if there were no other sensors installed that can be zeroed, then there would only be the six values displayed. They would be followed by a combination of six zeros and ones (usually all zeros). There would be a one in any of these locations where the corresponding zero or atmosphere adjustment was outside of the maximum range of adjustment.

For example: "1Z 000 1A 010 2Z -90 2A 102 3Z 000 4Z 165 001001<cr>" would show the offset values for six offsets, and show that offsets #3 and #6 were out of range. The first two stations are 4A's as they had both zero and atmosphere offsets. The -90 means that the zero offset of station #2 had reached the maximum range that could be corrected. The corresponding error bit indicates that it actually went beyond the maximum range that can be stored. Likewise, the zero offset went beyond the limit since its error bit was also set. The 010 would be the atmosphere offset for station #1, and the 102 would be the atmosphere offset value for station #2. If the first four stations were 2As, the example would be something like 1Z 000 2Z -90 3Z 000 4Z 165 0101.



**RS232/RS485 COMMAND SUMMARY**

NOTE: All commands that do not require a response otherwise, respond with an "A" and a carriage return if properly recognized. Whenever any command is not properly recognized, the Modular unit will respond with a question mark, "?" followed by a carriage return. All other command responses end with a carriage return. All "?<cr>" responses will be preceded by a letter indicating the reason for the rejection of the command. The following list gives the definitions of those letters; all other command responses end with a carriage return.

- A Atmospheric correction only allowed for 4A gauges
- C A non number was where a number should have been.
- D Disallowed, usually by the configuration of the unit.
- L Value inputted was too large.
- N Number not in range, or not a number.
- O Input buffer overloaded
- R Command not recognized.
- S Wrong sensor type.

COMMAND	RESPONSE
<b>BURST MODE</b>	
BF<cr>	Exit Burst Mode (can be stored).
BN<cr>	Go to Burst Mode (can be stored).
BO<cr>	Output Data in Burst Mode.
BRE<cr>	Burst mode, RS485 & every parity.
BRO<cr>	Burst mode, RS485 & odd parity.
SRE<cr>	Like "BRE", except default only.
SRO<cr>	Like "BRO", except default only.
SRC<cr>	Clears defaults for "SRE" and "SRO".
<b>COLD CATHODE</b>	
CAE<cr>	Changes mode of even station C/C gauge to AUTO.
CAO<cr>	Changes mode of odd station C/C gauge to AUTO.
CBE<cr>	Changes mode of even station C/C gauge to BOTH.
CBO<cr>	Changes mode of odd station C/C gauge to BOTH.
CFE<cr>	Turns off the high voltage to the even station C/C.
CFO<cr>	Turns off the high voltage to the odd station C/C.
CNE<cr>	Turns on the C/C gauge with an even station number.
CNO<cr>	Turns on the C/C gauge with an odd station number.
CPF<cr>	Cold cathodes are off at power up.
CPU<cr>	Cold cathodes as previous at power up.
CSE<cr>	Changes mode of even station C/C gauge to SELF.
CSO<cr>	Changes mode of odd station C/C gauge to SELF.





## COMMUNICATIONS (Can be stored)

AD<cr>	Add RS485 response delay.
AT<cr>	Add 50 millisecond command timeout.
BE<cr>	Blank echo.
CT<cr>	Clear 50 millisecond command timeout.
EAx<cr>	Enter RS485 address code "x".
EE<cr>	Enable echo.
G2<cr>	Go to the RS422 mode NOT USED
G4<cr>	Go to the RS485 mode.
PE<cr>	Insert and test for even parity.
PF<cr>	Turn off parity check and insertion.
PO<cr>	Insert and test for odd parity.
RA<cr>	Read RS485 address code byte.
RD<cr>	Remove RS485 response delay.
RR<cr>	Return to the RS232 mode.
SBll<cr>	Set baud rate (See Table).
SE<cr>	Store entries.

## CONFIGURATION

AR<cr>	Outputs relay configuration.
SC<cr>	Send all stations configuration.
Sx<cr>	Returns processor type installed in Station x.
SV<cr>	Send software version.

## DATA OUTPUT

Axxx<cr>	Output each marked station value every xxx cycles, where xxx is any value between 1 and 255.
BO<cr>	Output data in burst mode (See above).
CA<cr>	Cancel the automatic output.
Mx<cr>	Mark station x, where x is any number between 1 and 9, or A for Station 10.
Rx<cr>	One shot reading of station x.
Ux<cr>	Unmark station #x from automatic output.

## DISPLAY

DLx<cr>	Station x is displayed on the left side.
DRx<cr>	Station x is displayed on the right side.
D1E<cr>	1F gauges to be displayed in exponential form.
D1L<cr>	1F gauges to be displayed in linear form.
FA(cr)	In conjunction with the "FI" command, will inhibit all front panel function, except station select.
FE<cr>	Enables certain front panel functions, unless inhibited by the rear panel switch.



FI<cr>	Inhibits certain front panel functions.
UM<cr>	Causes Stations to be displayed in millibars.
UP<cr>	Causes stations to be displayed in Pascals.
UT<cr>	Causes stations to display in traditional units.
GAS	
GFx<cr>	Clears Station x from gas (Argon) operation.
GNx<cr>	Sets Station x for gas (Argon) operation.
HOT CATHODE	
AH<cr>	Auto Mode For Hot Cathode Gauges.
C2<cr>	Cancel filament enable by 24 volt signal
EB<cr>	Enable "both" modes of filament auto turn off.
E2	Enable control of filament by 24 volt signal.
EH<cr>	Enable Hot Cathode Gauges (shutdown mode).
FF<cr>	3D or 3E Filament OFF.
FN<cr>	3D or 3E Filament ON.
FNn<cr>	Select filament "n", #1 or #2 (3E only).
GF<cr>	3D or 3E Degas OFF.
GN<cr>	3D or 3E Degas ON.
GNxxx<cr>	3D or 3E Degas ON for "xxx" minutes, 255 max.
SWx<cr>	Make sensor switch setting equal "x" (logical).
SD<cr>	Send HC drive & I em
SS<cr>	Stop HC drive & I em
FM<cr>	Use of Soft 1.37 w/older units. Manual filament selection.
FR<cr>	Use of Soft 1.37 w/units with front panel filament select.
RS<cr>	Read switch position. Response "0" through "7".
R3Dx<cr>	Set full scale linear rec out. x is full scale range (exponent).
LEAK RATE	
ED<cr>	End Leak Rate data stream (but not the test).
EL<cr>	Stops Leak Rate test.
LR<cr>	Starts (or restarts) Leak Rate test. Time = 0.
RL<cr>	Read Leak Rate value periodically. "LR=nnnn" where nnnn is the leak rate in microns/hr.
OUTPUT FORMATS	
RF<cr>	Disable 0-10V outputs. They become indeterminate.
RN<cr>	Enable recorder outputs.
R1EL<cr>	Recorder output of 1Es & 1Fs to be logarithmic.
R1EN<cr>	Recorder output of 1Es & 1Fs to be linear.
R2AC<cr>	Recorder output of 2As to be 2C traditional.
R2AL<cr>	Recorder output of 2As to be logarithmic.
R2AN<cr>	Recorder output of 2As to be linear to (1) Torr.



R2AR<cr>	Recorder output of 2As to be reversed linear to (1) Torr.
R2AT<cr>	Recorder output of 2As to be 2A traditional.
R3DL<cr>	Recorder output of 3D or 3E to be logarithmic.
R3DM<cr>	Recorder output of 3D or 3E to be multi linear.
R3Dx<cr>	Recorder output of 3D or 3E to be linear to 10-x Torr where $8 \Rightarrow x \geq 2$ and 10V is at 10-x Torr.
R4AL<cr>	Recorder output of 4As to be logarithmic.
R4AN<cr>	Recorder output of 4As to be multi linear.
R4AT<cr>	Recorder output of 4As to be linear to 10 Torr.
R4AU<cr>	Recorder output of 4As to be linear to 1 Torr.
R5AL<cr>	Recorder output of 5As & 5Bs to be logarithmic.
R5AN<cr>	Recorder output of 5As & 5Bs to be linear.
R7BA<cr>	Recorder output of 7Bs to be 7AC traditional.
R7BE<cr>	Recorder output of 7Bs to be extended log.
R7BL<cr>	Recorder output of 7Bs to be logarithmic.
R7BM<cr>	Recorder output of 7Bs to be multi linear.
R7BN<cr>	Recorder output of 7Bs to be linear.
R7BT<cr>	Recorder output of 7Bs to be B7B2 traditional.
R7Ex<cr>	Recorder output of 7Es to be linear to 10-x Torr where $7 \Rightarrow x \Rightarrow 2$ and 10V is at 10-x Torr
R7FM<cr>	Recorder output of 7Fs to be multi linear. 1V/Decade and 9V is at 10-2 Torr.
R7FL<cr>	Recorder output of 7Fs to be logarithmic. 9V is at 10-2 Torr.
R7Fx <cr>	Recorder output of 7Fs to be linear to 10-x Torr Where $8 \Rightarrow x \geq 2$ and 10V is at 10-x Torr.
R7EL<cr>	Recorder output of 7Es to be logarithmic.
R7EM<cr>	Recorder output of 7Es to be multi-linear.
SET POINTS	
CPn<cr>	Clear setpoint values for relay "n".
PCA<cr>	Control all relays via RS232.
PCn<cr>	Control relay "n" via RS232.
PFn<cr>	Turn off controlled relay "n" via RS232.
PNn<cr>	Turn on controlled relay "n" via RS232.
PUA<cr>	Remove all relays from RS232 control.
PUn	Remove relay "n" from RS232 control.
SAXSy	Assign relay x to station y.
SPx<cr>	Send the station assignment of relay x.
SPxN<cr>	Send the "ON" setting of relay x.
SPxF<cr>	Send the "OFF" setting of relay x.
SSxFyyyyu<cr>	Set relay #x "OFF" to yyyy, units H or L.
SSxNyyyyu<cr>	Set relay #x "ON" to yyyy, units H or L.

**STATUS**

CF<cr>	Clear operational error bits.
DH<cr>	Perform diagnostics, but hold results.
DI<cr>	Modular unit performs internal diagnostics. Faults will be reported as " P5LO ..." If no faults "No Err ". In the burst mode, the response is in the form of six Hex nibbles.
RY<cr>	Send relay status
DP<cr>	Send previous (accumulated) faults.
ST<cr>	Output status of several variables.

**THERMOCOUPLE, CONVECTION AND DIAPHRAGM GAUGES ZEROING**

AF<cr>	Turns off adjustment for atmosphere.
AN<cr>	Turns on adjustment for atmosphere.
AP<cr>	Presets the atmosphere values to neutral.
Ayxxx<cr>	Adjusts station "y" to "xxx".
OZ<cr>	Output atmosphere and zero status.
ZA<cr>	Enable automatic zeroing of sensors.
ZC<cr>	Clear stored offsets.
ZF<cr>	Disable zeroing & auto zeroing of sensors.
ZN<cr>	Enable zeroing of sensors.
ZO<cr>	Disable automatic zeroing of sensors.
Zn<cr>	Zero station "n" reading.

**RS485 HOST COMMAND SET**

Special commands are used for addressing individual units on the RS485 bus, and for sending "broadcast" commands.

RS485 is always used with echoes blanked, and is usually in the burst mode. The front panel is also disabled, except that a local operator may be allowed to change the stations that are shown in the two displays.

Addressing a unit enables the unit to respond to the command that immediately follows the address, if the address corresponds to the unit's preset address. When a unit has been addressed, the command that immediately follows is exactly the same as used for RS232. The unit that receives a command after receiving it's address shall comply with the command, and respond the same as when RS232 is being used. Up to thirty-one units may be addressed by a host. (Together with the host, this makes the maximum of 32 nodes on the RS485 network).

Broadcast commands are those commands that all units receive and process. Units do not respond with an answer after receiving a broadcast command. To do so would cause contention on the bus, and would be unintelligible to the host.

All other transmissions on the RS485 bus are ignored by units, such as commands to other units, and responses from other units.



Except for the address and broadcast commands, all other communications on the RS485 bus shall have the format of one start bit, seven data bits+parity (or eight bits including parity, depending on the terminology used by the host software), and one stop bit. If no parity is selected, then the format is one start bit, eight data bits, and two stop bits.

NOTE: All communications are in ASCII.

The unit address and the broadcast command set is shown in the table below. These codes are case sensitive.

### ADDRESSING INDIVIDUAL UNITS

There are two methods available to address individual units or to send broadcast commands.

The standard method to address an individual unit, the host communications format is set to one start bit, eight data bits, even parity, where parity is in the ninth bit, and one stop bit(s). Under "Box Addresses" below, in the first and third columns "NBMR" is the number of the individual unit. In the second and third columns "CODE" is the character sent by the host to address that unit. When a unit receives it's code, the serial input port is enabled to receive the command that follows. The commands are then identical to those given for RS232 operation. After reception of the command, the input buffer is reset to receive another address or broadcast command.

An alternate method is available for software versions 1.36 to 2.13. This method is to precede an address with a dollar sign "\$". The MM200 will test each character to see if it is a \$ and then test the next character to see if it is the unit's address. The choice of the \$ is arbitrary and could be replaced by any of approximately 16 available characters if other units on the RS485 line are already assigned this symbol.

### BROADCAST COMMANDS

When a "broadcast" command is sent, all units are required to process the command.

The standard format that the host uses to send a broadcast command is one start bit, eight data bits, odd parity, where parity is in the ninth bit, and one (or two) stop bit(s). No response should be given by any of the units over the RS485 bus. In the table below under "broadcast commands", the first column is the character sent by the host to invoke the command. The second column gives the equivalent RS232 command that applies to all units. The "X" command is like a clear command that is equivalent to all four of the RS232 commands shown.



The same alternate as above is available for broadcast commands as was discussed above.

UNIT ADDRESSES				BROADCAST COMMANDS			
NO	CODE	NO	CODE	CODE	COMMAND		
1	0	17	V	1	BN	Burst mode	
2	3	18	Y	2	BE	Blank echoes	
3	5	19	Z	4	PE	Even parity	
4	6	20	c	7	PF	Parity off	
5	9	21	e	8	PO	Odd parity	
6	A	22	f		C	FA	Inhibit some PBs
7	B	23	i		E	FE	Enable all PBs
8	D	24	j		F	FI	Inhibit some PBs
9	G	25	l		I	AH	HC filament auto
10	H	26	o	J	EH		Enable HC(no T/C)
11	K	27	q	L	FF		Filament OFF
12	M	28	r	O	FN		Filament ON
13	N	29	t	Q	GF		Degas OFF
14	P	30	w	R	GN		Degas ON
15	S	31	x	T	PCA		Control all relays
16	U			W	PUA		Control no relays
			X	BN, BE, FA, FI			
				a	DH		Do Diagnostics & hold results

NOTE: Codes are case sensitive.

**RS232 COMMANDS USED TO IMPLEMENT RS485**

- "G2<cr>"                      Go to RS422 mode. The command is normally issued through the RS232 port. RS422 requires use of the RS485 full duplex module. NOT YET AVAILABLE.
- "G4<cr>"                      Go to the RS485 mode. This command is entered through the RS232 or RS422 port. This command also implements the following other command: BE. The MPU is set up to interpret addresses and broadcast commands. The input is then switched to the RS485 port. This mode will be aborted when any character is received via the RS232 port.
- "RA<cr>"                      Read the unit address.
- "EAn<cr>"                      Set the unit address to "n", where "n" is the address code from the table above. This address code may be stored using the "SE<cr>" command.



**ALTERNATE ADDRESS SCHEME FOR RS485**

The scheme consists of prefixing the address with a printable character not normally used by the MM200. Hopefully, at least one of the characters available will not be used by other types of units on the same bus as the MM200's. The default characters are the dollar sign "\$" for the unit address and the ampersand "&" for broadcast commands. These characters can be changed. The table below lists available characters.

CHAR	CODE	CHAR	CODE	CHAR	CODE	CHAR	CODE
"	A	'	F	:	K	]	Q
#	B	(	G	;	L	{	R
\$	C	)	H	<	M		S
%	D	*	I	>	O	}	T
&	E	/	J	\	P	~	U

Even if MM200's are the only units on a particular bus, the main idea is to make it simpler to program.

The commands that are used to install these characters are:

RI1<cr> is used to insert a new address prefix, where 1 is the letter chosen from the above table. It is necessary to use a code letter since the input buffer of the MM200 will ignore and not store the characters themselves. When used, this prefix is followed by the same unit address that is given in the RS485 protocol. The address is followed by any of the normal valid RS232 commands. This is now done without parity or word length changes.

BI1<cr> is used to insert a different broadcast command prefix. The same table given above is used to select the code letter associated with the desired character. When used, this prefix is followed by the broadcast command (no unit address).

The alternate or standard mode of RS485 addressing can be selected with the following commands:

- UA<cr> selects this new alternate method
- US<cr> selects the previous standard method

Newly entered prefixes and the mode selection can be stored with the "SE<cr>" command. Use RS232 to enter these commands.

**SPECIAL COMMANDS**

The following commands are available for test purposes but are not listed with the other normal commands. The password is not required to use these commands.

- "ES<cr>" Enable HV short detect
- "SI<cr>" Inhibit HV short detection
- "SD<cr>" Send hot cathode drive signal continuously.
- "SS<cr>" Stop sending hot cathode filament drive.



**RS232  
HARDWARE**

The MM200 uses a DE9S connector (female) for RS232 and the RS485 hardware interface. The pinouts are in accordance with Fig. 6.1 and Table 6.1.

PIN	FUNCTION
2	Tx - from MM200
3	Rx - to MM200
4	DTR - to MM200
5	GROUND
6	DSR - TO MM200
7	DO NOT USE
8	DO NOT USE
1	RS485 (Same as "B")
9	RS485 (Same as "A") *

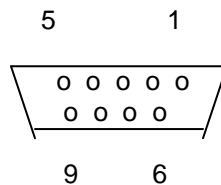

\* For PCB # 3900G105 (See copper side)  
- Not connected for "F" revision and lower.

**RS485  
HARDWARE**

The MM200 uses a 3 pin connector for the RS485 hardware interface. The pinouts are in accordance with Figure and table. One possible way to interconnect is shown below using a 485TBLED converter.

PIN	FUNCTION
B	Lead "B"
A	Lead "A" (Less + at IDLE mode)
G	Ground



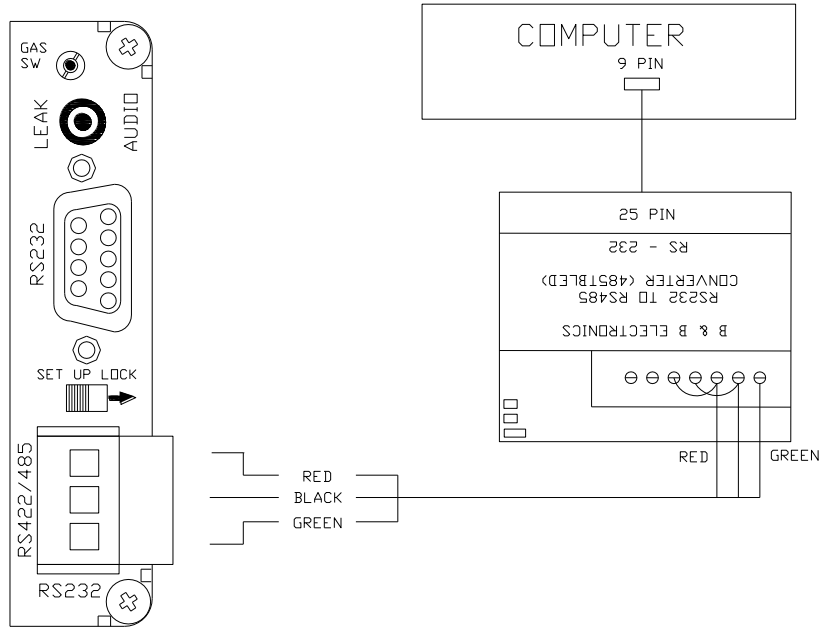

**605 COMMUNICATIONS - FOR SOFTWARE VERSIONS 1.21 – 1.34**

**RS232**

**PROTOCOL** The Televac Modular Vacuum Gage accepts various sensors and relay modules. Upon power-up, the processor determines the actual configuration of the Modular unit by way of electrical tests.

Aside from the front panel operation of the modular unit, there are a number of commands that can be issued by way of the RS232 or RS485 interface (comm. interface) to control the operation of the modular unit.

A summary of these commands is given below, followed by a detailed description. The commands are separated into groups, where in each group the commands relate to a common subject.

Note that in the following discussion, where quotation marks are used, they are neither a part of command nor of the response. Also, the symbol "<cr>" refers to the sending of a carriage return, either in the command, or in the response. All commands will produce a response, so that the host will know that the command has been received.

If a command is not recognized as a legitimate command, the response will be a question mark "<cr>". Commands that do not require a response otherwise, will respond with "A<cr>" to indicate that the command has been received and the required action will be taken.

The communication protocol requires eight bits of data, one start bit and one stop bit. The use of parity is optional, as can be seen under the communications commands. The parity bit, if used,



occupies the eighth bit of data, so that depending on the communications software used, the data length may have to be changed to seven bits (as the parity bit is then added after the seventh bit).

The default data rate on a new unit is 9600 baud, but may be changed by way of the comm. interface to 300, 600, 2400, 4800, or 9600 baud.

A description of the various commands follows. They are separated into the different categories. First is presented a Command Summary followed by a detailed description of the commands.

## 606 COMMAND SUMMARY - FOR SOFTWARE VERSIONS 1.19 - 1.20

NOTE: All commands that do not require a response otherwise, respond with an "A" and a carriage return if properly recognized. Whenever any command is not properly recognized, the Modular unit will respond with a question mark, "?" followed by a carriage return. All other command responses end with a carriage return. Commands which are not stored using the "SE<cr>" command will be lost when powder is interrupted and unit is repowered.

COMMAND	RESPONSE
<b>"B" MODE</b>	
BF<cr>	Exit "B" Mode (can be stored).
BN<cr>	Go to "B" Mode (can be stored).
BO<cr>	Output Data in "B" Mode.
<b>COLD CATHODE</b>	
AC<cr>	Auto Mode for Cold Cathode Gauges.
EC<cr>	Turn Cold Cathode Gauges "ON".
NC<cr>	Turn Cold Cathode Gauges "OFF".
<b>COMMUNICATIONS (Can be stored)</b>	
BE<cr>	Blank echo.
EE<cr>	Enable echo.
PE<cr>	Insert and test for even parity.
PF<cr>	Turn off parity check and insertion.
PO<cr>	Insert and test for odd parity.
SBll<cr>	Set baud rate. (See Table in Section 603).
SE<cr>	Store entries.
<b>CONFIGURATION</b>	
AR<cr>	Outputs relay configuration.
DI<cr>	Modular unit performs internal diagnostics. Faults will be reported as " P5LO ..." If no faults "No Err ".
Sx<cr>	Returns module type installed for Station x.
SV<cr>	Send software version.



## DATA OUTPUT

Axxx<cr>	Output each marked station value every xxx cycles, where xxx is any value between 1 and 255.
CA<cr>	Cancel the automatic output.
Mx<cr>	Mark station x, where x is any number between 1 and 10, 9, or A for Station
Rx<cr>	One shot reading of station x.
Ux<cr>	Unmark station #x from automatic output.

## DISPLAY

DLx<cr>	Station x is displayed on the left side.
DRx<cr>	Station x is displayed on the right side.
FA(cr)	In conjunction with the "FI" command, will inhibit all front panel function, except station select.
FE<cr>	Enables all front panel functions, unless inhibited by the rear panel switch.
FI<cr>	Inhibits certain front panel functions.
UM<cr>	Causes Stations to be displayed in millibars.
UP<cr>	Causes stations to be displayed in Pascals.
UT<cr>	Causes stations to display in traditional units.

## GAS

GFx<cr>	Clears Station x from gas operation.
GNx<cr>	Sets Station x for gas (Argon) operation.

## HOT CATHODE

AH<cr>	Auto Mode For Hot Cathode Gauges.
EH<cr>	Enable Hot Cathode Gauges (shutdown mode).
FF<cr>	3D Filament OFF.
FN<cr>	3D Filament ON.
GF<cr>	3D Degas OFF.
GN<cr>	3D Degas ON.
GNxxx<cr>	3D Degas ON for "xxx" minutes, 255 max.
SWx<cr>	Make sensor switch setting equal "x".

## LEAK RATE

ED<cr>	End Leak Rate data stream (but not the test).
EL<cr>	Stops Leak Rate test.
LR<cr>	Starts Leak Rate test. Time = 0.
RL<cr>	Read Leak Rate value periodically. "LR=nnnn" where nnnn is the leak rate in microns/hr.

## OUTPUT FORMATS

R1EL<cr>	0-10V of 1Es to be logarithmic.
R1En<cr>	0-10V of 1Es to be linear.



R2AC<cr> 0-10V of 2As to be MP2C traditional.  
 R2AL<cr> 0-10V of 2As to be logarithmic.  
 R2AN<cr> 0-10V of 2As to be linear to (1) Torr.  
 R2AT<cr> 0-10V of 2As to be 2A traditional.

R3DL<cr> 0-10V of 3D to be logarithmic.  
 R3DM<cr> 0-10V of 3D to be multi linear.

R4AL<cr> 0-10V of 4As to be logarithmic.  
 R4AN<cr> 0-10V of 4As to be standard.

R7BE<cr> 0-10V of 7Bs to be extended log.  
 R7BL<cr> 0-10V of 7Bs to be logarithmic.  
 R7BM<cr> 0-10V of 7Bs to be multi linear.  
 R7BN<cr> 0-10V of 7bs to be linear.

R7EL<cr> 0-10V of 7Es to be logarithmic.  
 R7EM<cr> 0-10V of 7Es to be multi-linear.

SET POINTS

PCA<cr> Control all relays via RS232.  
 PCn<cr> Control relay "n" via RS232.  
 PFn<cr> Turn off controlled relay "n" via RS232.  
 PNn<cr> Turn on controlled relay "n" via RS232.  
 PUA<cr> Remove all relays from RS232 control.  
 PUn Remove relay "n" from RS232 control.  
 SAxSy Assign relay x to station y.  
 SPx<cr> Send the station assignment of relay x.  
 SPxN<cr> Send the "ON" setting of relay x.  
 SPxF<cr> Send the "OFF" setting of relay x.  
 SSxFyyyyu<cr> Set relay #x "OFF" to yyyy, units H or L.  
 SSxNyyyyu<cr> Set relay #x "ON" to yyyy, units H or L.



**HARDWARE**

and the RS485 hardware interface. The pinouts are in accordance with Fig. 6.1 and Table 6.1.

PIN	FUNCTION
2	Tx - from MM200
3	Rx - to MM200
4	DTR - to MM200
5	GROUND
6	DSR - TO MM200
7	DO NOT USE
8	DO NOT USE

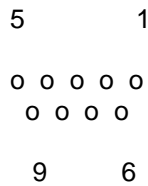



## COMMANDS

A detailed description of the various commands follows. They are separated into the different categories.

NOTE: Commands which are not stored using the "SE<cr>" command will be lost when powder is interrupted and unit is repowered.

### "B" MODE COMMANDS

"BF<cr>"

1. Exit "B" mode. This command causes the processor to exit the "B" mode and enter "normal" communication mode. See the next two commands for a description of the "B" mode.

"BN<cr>"

2. Enter the "B" mode. This command causes the processor to go into the "B" mode. The "B" mode provides a means to dump the readings of all processors in a compact and fast manner. There are some restrictions to using the "B" mode. If two relay modules are installed, (eight relays) then only three sensors can be accommodated in this mode. If one relay board is installed, then up to seven sensors can be accommodated. If no relay modules are installed, then a full complement of ten sensors can be accommodated. This command can be stored so that at power up, the modular unit will be in the "B" mode. Storing the "BF" command will cancel the storing of this command.

"BO<cr>"

3. Output data in the "B" mode. This command causes an uninterrupted dump of the data of all installed sensors. The data is stored in RAM so there is no need to wait for any sensors to be measured to respond to this command.

The format of the data is four ASCII characters for each sensor starting with the lowest numbered sensor up to the highest numbered station in sequence.

For all sensors the format is the same, three significant digits and an exponent. There is an implied decimal point between the first and second digits, and an implied sign for the exponent. The sign can be positive or negative depending upon the sensor. There are no delimiters in the data stream. If an exponent goes to ten an "A" will be sent for the exponent. For an exponent of eleven, a "B" will be sent.

If a 3D hot cathode module is present, several special codes are used. If the 3D has been turned "OFF" via RS232, an "R" will be sent instead of the four digits. If it



has been shut off due to going over range an "S" will be sent. If it is off due for any other reason an "F" will be sent.

#### RESTRICTIONS WHEN USING THE "B" MODE

The "B" mode provides for a very rapid dump of data from all installed sensors through the communications port. To do this, data is stored in RAM that is normally used for other functions. This places the following restrictions on the configuration of the MM200.

If there are no relay modules installed, then there are no restrictions on the configuration except for available space.

If one relay module installed, then only seven other sensors may be installed, space permitting.

If two relay modules are installed, then only three sensors may be installed, space permitting.

#### COLD CATHODE

"AC<cr>"

1. Go to the automatic mode. This causes the cold cathode to be controlled by a thermocouple or convection type gauge. If the cold cathode gauge has an odd station number, it will be controlled by the thermocouple or convection type gauge with the lowest station number. This is the default setting when power is applied.

If the cold cathode gauge has an even station number, it will be controlled by the thermocouple or convection type gauge with the second lowest station number.

By control, is meant that the high voltage will go off and the station will use default outputs if the pressure at the controlling gauge exceeds a certain pressure. That pressure is 20 microns if either a 7E or 3D is installed, otherwise the control pressure is 10 microns.

"EC<cr>"

2. Turn cold cathode gauges ON. This command causes all cold cathode gauges to be ON regardless of pressure at any of the other gauges.

"NC<cr>"

3. Turn cold cathode gauges OFF. This command causes all cold cathode gauges to be "OFF" until some future command changes the allows them to operate again.



## COMMUNICATIONS

All of these commands can be stored so that they will be in effect at power up.

- "BE<cr>" 1. Blank the echo. This command causes the modular unit not to echo commands. However, the appropriate responses to the commands will still be given.
- "EE<cr>" 2. Enable the echoing of the command characters. This command causes all command characters to be echoed to the host. This is the default setting for a new unit. It can be stored, in which case the stored "BE" command is canceled.
- "PE<cr>" 3. Insert and test for even parity. This command causes the modular unit to insert, as required, in the eighth data bit location, a bit to cause the parity to be even (an even number of one bits). The modular unit also tests to see if the received characters have even parity, if not, the modular unit sends an exclamation mark "!" before the next character that is to be sent. The only exception to this is in the "BN" mode, after a "BO" command, the carriage return mark is sent at the beginning of the data stream. Note that, even when there is a parity error detected, the modular unit responds to all commands in the normal manner, except for the inclusion of the exclamation mark.
- Whenever the echoes are being blanked, the exclamation mark is only sent after the command is completed, and means that the parity error could have occurred anywhere in the command string.
- "PF<cr>" 4. Turn OFF the parity check. This command cancels parity check and insertion for type of parity. This is the normal default mode for the modular unit.
- "PO<cr>" 5. Insert and test for odd parity. This is the same as number three above, except for odd parity.
- "SBII<cr>" 6. Set the baud rate. This allows the operator to change the baud rate. "II" is a letter that is repeated for redundancy sake. The baud rate changes according to the following table:

AA	300 baud
BB	600 "
CC	1200 "
DD	2400 "
EE	4800 "
FF	9600 "





The modular unit responds with "A<cr>" prior to changing its baud rate. Any further communications must be performed at the new baud rate. (See next command to store this value.

"SE<cr>"

7. Store all default values. This command causes all storable data to be stored in the EEPROM, so that they will be in effect at power up.

When the baud rate is changed by the command above, this command should be given at the new baud rate, if it is desired for the modular unit to be at the new baud rate after power has been removed and re-applied. It should be noted that if the display units had been changed prior to using this command, then the new units will be displayed the next time that power is applied. The response to this command is "A<cr>".

The configuration of the Modular unit (i.e. what relays and types of sensors are plugged in and what their assignments are) can be determined through the use of several commands.

"AR<cr>"

1. Send the relay configuration. The modular unit will respond with the relay configuration in one of these formats:

"RY=0,0" "RY=1,0" "RY=0,2" or "RY=1,2" depending on which relay modules are inserted. Each relay module contains four relays. These are referred to as PCR1, PCR2, ....etc. The first module, if installed, provides PCR1 through PCR4. A second module, if installed, provides PCR5 through PCR8.

"DI<cr>"

2. Have the Modular unit perform self-diagnostics, and report the results. The typical form of the response is "P15L N12H ...", where "P15L" means that the plus fifteen volt supply is low, and "N12H" means that the negative twelve volt supply is high (absolute). If there are no faults, the response is "NO-err".

"Sx<cr>"

3. Send module type for a specific station. The modular unit responds with the sensor type that is installed in station "x". For example if "S1<cr>" were sent, and station number 1 contained a Model 2A thermocouple module, the response would be "S1=2A<cr>". If station 1 were not occupied, the response would be "S2=none<cr>". If the configuration test showed a faulty unit, the response would be "S2=flty<cr>".

Successive use of this command (up to ten station max.) will indicate the make-up of the modular unit with respect to its complement of stations.



"SV<cr>"

4. Fetch the modular unit software version. The modular unit responds with "Ver n.nn<cr>", where n.nn is the version number.

## DATA OUTPUT

"Annn<cr>"

1. Automatically output periodic readings from any selected number of the sensors. Where "nnn" is any number from 001 to 255. Note that three digits must be sent including lead zeros. All marked stations (see below) shall have their readings output at the end of "nnn" loops of measuring all the station between outputs is approximately  $(0.11)(nnn)(N)$ . Where N = the number of stations that are installed in the modular unit, no matter how many stations are having their data outputted. This feature is not available in the "B" mode. The data output is in the same format as for the "Rx<cr>" command below, except that for a given set of outputs, the marked station outputs are preceded by a blank space. The last (marked) station value output is followed by a carriage return.

For example if eight stations are installed, stations 1, 4, and 7 are marked, and the command "A010<cr>" is sent. Approximately every 8.8 seconds the modular unit would output something like:

" 1=1.23+3U 4=4.50+1U 7=1.10-5T<cr>"

"CA<cr>"

2. Cancel automatic output of data. This command causes the automatic output of data to cease. It does not "unmark" stations, they stay marked, and if the "Annn<cr>" command is again given, the output of data from those stations that were marked will resume. The response to this command is "A<cr>".

"Mx<cr>"

3. Mark the stations from which the above automatic readings shall be received. Where x is the number of the station to be "marked" for automatic output (one station at a time). The response to this command is "A<cr>".

"Rx<cr>"

4. Obtain individual vacuum readings from the various sensors. Where x is the station from which a reading is desired. This command cannot be used when in the "B" mode.

The response to this command is in the same format for all types of sensors. That is, the response is in exponential form. The form is "n=x.xx(+ or -)yu", where "n" is the station number, "x.xx" is the value given to two decimal places, followed by either a plus or a minus, followed by the exponent (power of ten), followed by either a "U" for microns or a "T" for Torr. For example, a Model 2A thermocouple at station #2 might respond "2=2.45+2U", corresponding to a pressure reading of 245 microns. This command should not be used at the same time that the "Annn<cr>" command is being used, and none of the stations should be marked for automatic output when this command is used.



- "Ux<cr>" 5. Unmark stations. This command removes stations from automatically having their data outputted. All marked stations should be unmarked with this command prior to using the "Rx<cr>" command (above). The response to this command is "A<cr>".
- DISPLAY
- "DLx<cr>" 1. Change the stations being displayed on the front panel in the left hand display. This causes the left hand display-to-display station "x".
- "DRx<cr>" 2. Change the station being displayed on the front panel right hand display. This causes the right hand display-to-display station "x".
- Both of these functions can be overridden by a local operator. The response to these commands is "A<cr>".
- "FI<cr>" 3. Disable the ability of a local operator to change set-point assignments and settings, or to change the Gas/No-Gas assignments from the front panel. This has the same effect as the inhibit switch on the back panel of the modular unit. The response is "A<cr>".
- "FE<cr>" 4. Enable a local operator to make the changes inhibited by the previous command and the next command. Except that the local operator will not be able to make these changes if the rear panel inhibit switch is activated. The response is "A<cr>".
- "FI<cr>" 5. Inhibit additional front panel commands. This command, when used with the "FA" command will inhibit all front panel push buttons, except the up down arrows which will only let the local operator view the various stations.
6. Change the "Units" in which the Modular unit is displaying readings. There are three separate commands for this function:
- "UM<cr>" Causes both displays to display in millibars.
- "UP<cr>" Causes both displays to display in Pascals.
- "UT<cr>" Causes stations to be displayed in Televac traditional units. For example a cold cathode station would be displayed in Torr, a thermocouple or convection sensor would be displayed in either Torr or microns, depending upon the magnitude of the pressure.
- The response in all three cases is "A<cr>".



## GAS (Argon, etc.)

"GFx&lt;cr&gt;"

1. Remove a station from "Gas" operation. The "x" is the station number of the station being removed from operation with "Gas". The operation is the reverse of "GNx<cr>" below. The response to this command is "A<cr>".

"GNx&lt;cr&gt;"

2. Assign a station to operate with Gas. Where "x" is the station to be switched to have it's response calibrated for gas. This command is different from assigning "Gas" from the front panel in that it does not matter whether or not the station is being displayed in the right hand display. In order for a station to be selected for "Gas" operation by way of the front panel push button, the station must be being displayed in the right hand display. The response to this command is "A<cr>".

## HOT CATHODE

"AH&lt;cr&gt;"

1. Go to the AUTO mode. The command causes the resident hot cathode gauge to be controlled by the thermocouple or convection gauge that has the lowest station number.

By control is meant, should the pressure of the controlling sensor exceed twenty microns, the hot cathode filament will shut off. It will come back on when the pressure of the controlling sensor goes below 20 microns.

"EH&lt;cr&gt;"

2. Go to the SHUT-DOWN mode. This takes the hot cathode gauge out of the AUTO mode or out of the OFF mode and allows it to shut itself down by virtue of it reading a pressure above it's normal range. When so shut down, it must be restarted either through the front panel commands, or through the RS232 "FN" command.

"FF&lt;cr&gt;"

3. Turn the hot cathode filament OFF. This command turns off the filament of the hot cathode gauge. The filament cannot be turned on neither through the front panel controls, nor through the control of it's associated thermocouple or convection gauge.

"GF&lt;cr&gt;"

4. Turn the 3D de-gas OFF. This command stops the de-gas function if it is active. This does not inhibit setting up de-gas via the front panel. This is the only way the degas can be halted, if it was started by the "GN<cr>" command.

"GN&lt;cr&gt;"

5. Turn the 3D de-gas ON. This command turns the 3D de-gas on for an indefinite period of time. To shut it off, the "GF" command must be used. (Shutting power OFF and back ON will also reset the de-gas).



"GNxxx<cr>"

6. Turn the de-gas on for a specified period of time. This will turn on the de-gas for "xxx" minutes, where "xxx" is anywhere from 001 to 255. Three digits must be sent including lead zeros, if any. The front panel will flash the de-gas time the same as if it were set from the front panel, except that while the de-gas time is over 99 minutes; the display will flash "dG--".

"SWx<cr>"

7. Logically set the rear panel 3D filament selector switch. This makes the modular unit respond as if the rear panel switch were set to "x". (The switch physically remains as it was).

#### LEAK RATE

"ED<cr>"

1. End Leak Rate data output. This command halts the output of leak rate data to the comm. interface, but does not stop the leak rate test. It can be used when it is desired to momentarily interrupt the data flow, without interrupting the test itself, so that other commands could be exercised. The front panel continues to display the leak rate test results (updated once each second). The response to this command is "A<cr>".

"EL<cr>"

2. End the leak rate test. This command causes the leak rate test to cease, the same, as the front panel push button would do if pressed while the leak rate test is in progress. The response to this command is "A<cr>".

"LR<cr>"

3. Initiate Leak Rate testing. The results are the same as pressing the front panel "leak rate" push button. Whenever this command is issued the leak rate test starts at time "zero". This command can be used for resetting the test time to "zero", if the test is already in progress. The front panel responds the same as if the front panel push button had been pressed, that is, the right hand display shows the leak rate values. It differs in that if the unit is in the leak rate test, pressing the front panel push button will end the leak rate test. The response to this command is "A<cr>". Leak rate tests always use station #1 as the sensor.

"RL<cr>"

4. Periodically obtain Leak Rate readings. This command causes the modular unit to periodically output the leak rate reading. The data is in the form of four digits, which include any lead zeros, followed by a carriage return such as "0015<cr>". The four digits give the leak rate in microns per hour (the same as displayed on the front panel). The data is outputted once every second (regardless of the setup of the modular unit). The initial response to this command is "A<cr>". None of the leak rate functions above are available when in the "B" mode. If any are in effect when entering the "B" mode, they are canceled. However, the front panel leak rate function is available during operation in the "B" mode.



## OUTPUT FORMATS

"Rssf<cr>" Set recorder output of a particular type sensor to a particular format. Where "ss" is the sensor type and "f" is the format. See the list under the "Command Summary" for the available formats.

## SET POINTS

- "PCA<cr>" 1. Control all relays via the comm. interface. In order for a relay to be controlled via the comm. interface, its control must first be passed over to that interface. This is to prevent confusion between being turned on or off by the assigned sensor or by the comm. interface. This command passes the control of all relays to the comm. interface simultaneously.
- "PCn<cr>" 2. Assign the control of one relay to the comm. interface. Where "n" is the relay number. The same as above, except the control of just one relay is passed.
- "PFn<cr>" 3. De-energize a particular relay via the comm. interface. Where "n" is the relay number. The relay must first be assigned to be controlled via the comm. interface by either the "PCA" command or the "PCn" command.
- "PNn<cr>" 4. Energize a particular relay via the comm. interface. As (3) above, except that it energizes the relay.
- "PUA<cr>" 5. Remove all relays from control by the comm. interface. This is the reverse of the "PCA" command.
- "PUn<cr>" 6. Remove a single relay from control via the comm. interface. Where "n" is the relay number being removed from control via the comm. interface. Control of this relay then reverts to whatever sensor it had been assigned to.
- "SAxSy<cr>" 7. Assign a particular relay to a particular sensor. This assigns control of relay "x" to station "y". The response to this command is "A<cr>". If stored, this will then be the default station at power-up.



- "SPx<cr>" 8. Send the station assignment of a particular station. This causes the modular unit to respond with the station number assigned to relay "x" followed by a "<cr>".
  
- "SPxN<cr>" 9. Send the ON setting of a particular relay. This causes the modular unit to respond with the ON set point setting of relay "x". The response to this command is a four-digit number including lead zeros followed by a "<cr>". The format of the response is the same as for the "SSxFyyyyu" command below.
  
- "SPxF<cr>" 10. Send the OFF setting of a particular relay. This causes the modular unit to respond with the OFF set point setting of relay "x". The response to this command is a four-digit number followed by a "<cr>". The format is the same as for the "SSxFyyyyu" command below.
  
- "SSxFyyyyu<cr>" 11. Set the OFF set point of a particular relay. Where "x" is the relay number for which it is desired to set the dropout (de-energize) point, and "nnnn" is the setting. The response to this command is "A<cr>". See the chart below (next page) for ranges of settings for various sensors.
  
- "SSxNyyyyu<cr>" 12. Set the ON set point of a particular relay. Where "x" is the relay number, and "nnnn" is the setting. See the chart below (next page) for ranges of settings for various sensors.

**SET POINT SETTING VALUES**

<b>SENSOR</b>	<b>UNITS</b>	<b>RANGE</b>	<b>SETTING</b>
2A	MICRONS	0-1000	0001L to 0999L
	TORR	1.0-20.0	0010H to 0200H
3D	TORR	0.0e-11 to 9.9e-2	0.0-B to 9.9-2
4A	MICRONS	1-1000	0001L to 0999L
	TORR	1-1000	0001H to 0999H
1E	TORR	1-1000	0001L to 0999L
7B	TORR	1e-6 to 1.5e-3	0001L to 0990L
7E	TORR	1.0e-8 to 9.9e-6	0001L to 0990L
	TORR	1.0e-5 to 9.9e-3	0001H to 0990H



## 607 COMMUNICATIONS - FOR SOFTWARE VERSIONS 1.0 - 1.19

**RS232 PROTOCOL** The Televac Modular Vacuum Gage accepts various sensor and relay modules. Upon power-up, the processor determines the actual configuration of the Modular unit by way of electrical tests. Note that in the following discussion where quotation marks are used, they are not a part of either the command nor of the response. Also, the symbol "<cr>" refers to the sending of a carriage return, either in the command, or in the response. All characters received by the modular unit are echoed back to the terminal or computer.

The communication protocol requires eight bits of data, no parity bit and one stop bit. The default data rate on a new unit is 1200 baud, but may be changed by way of the RS232C interface to 300, 600, 2400, or 9600 baud.

By way of RS232C interface, a remote operator is capable of performing the following functions.

1. Determine the configuration of the Modular unit (i.e. what relays and types of sensors are plugged in and what their assignments are). This can be done through the use of several commands.

- A. Command "AR<cr>" will respond with the relay configuration in one of the formats:

"RY=0,0" "RY=1,0" "RY=0,2" or "RY=1,2" corresponding to whether "no relays", "relay module one", "relay module two" or "both relay modules" are inserted. Each relay module ( 2 maximum) contains four relays. There are referred to as PCR1, PCR2,...etc. The first module, if installed, provides PCR1 through PCR4. A second module, if installed, provides PCR5 through PCR8.

- B. Command "Sx<cr>" responds with the processor type that is installed in station "x".

For example if "S1<cr>" were sent, and station no. 1 contained a Model 2A thermocouple module, the response would be "S1=2A". If station 2 were not occupied, the response would be "S2=none". If the configuration test showed a faulty unit, the response would be "S2=flyt".

Successive use of this command (up to ten station max.) will indicate the make-up of the modular unit with respect to it's complement of stations.

- C. The assignment and settings of the various set-points can be determined using commands described later.





2. Obtain individual vacuum readings from the various sensors. This is accomplished with the "Rx<cr>" command, where x is the station from which a reading is desired.

The response to this command is in the same format for all types of sensors. That is, the response is in exponential form. The form is "n=x.xx(+ or -)yz", where "n" is the station number, "x.xx" is the value give to two decimal places, followed by either a "U" for microns or a "T" for torr. For example, a Model 2A thermocouple at station #2 might respond "2=2.45+2U", corresponding to a pressure reading of 245 microns. This command should not be used at the same time that the "Annn<cr>" command is being used, and none of the stations should be marked for automatic output. These commands are discussed later.

3. Automatically receive periodic readings from any selected number of the sensors.

The form of this command is "Annn<cr>" where "nnn" is any number from 001 to 255. Note that three digits must be sent including lead zeros. All marked stations (see below) shall have their readings output at the end of "nnn" loops of measuring all the stations that are installed. The time between outputs is approximately  $0.11 * nnn$  (the number of stations that are installed in the modular unit, no matter how many stations are having their data outputted). The data output is in the SAME format as for the "Rx<cr>" command above, except that for a given set of outputs, the marked station outputs are followed by a blank space, except that the last (marked) station value output is followed by a carriage return. For example, if eight stations are installed, stations 1, 4, and 7 are marked, and the command "A010<cr>" is sent. Approximately every 8.8 seconds the modular unit would output something like:

"1=1.23+3U 4=4.50+1U 7=1.10-5T<cr>"

4. Cancel automatic output of data.

This command is "CA<cr>", and causes the automatic output of data to cease. It does not "unmark" stations, they stay marked, and if the "Annn<cr>" command is again given, the output of data from those stations that were marked will resume. The response to this command is an "A" followed by a "<cr>".

5. Mark the stations from which the above automatic readings shall be received.

This is accomplished with the "Mx<cr>" command, where x is the number of the station to be "marked" for automatic output (one station at a time). The response to this command is an "A" followed by a "<cr>".



6. Unmark stations.

This command "Ux<cr>", removes stations from automatically having their data outputted.

All marked stations should be unmarked with this command prior to using the "Rx<cr>" command (above). The response to this command is an "A" followed by a "<cr>".

7. Read set-point assignments.

This command is "SPx<cr>", where "x" is the set-point whose assignment is desired to be known. The response is simply the station number followed by a "<cr>".

8. Change a set-point assignment.

This command is "SAxSy<cr>", where "x" is the PCR number, and "y" is the station to which it is to be assigned. The response to this command is an "A" followed by a "<cr>".

9. Disable the ability of a local operator to operate the SETUP pushbutton, the TEST pushbutton, the GAS pushbutton or units selection from the front panel. This command is used when total automatic control is desired with no interference in RS232 operation caused by operation of front panel pushbuttons.

This command is "FA<cr>". The response is an "A" followed by a "<cr>".

10. Disable the ability of a local operator to change setpoint assignments, setpoint settings or to change the Gas/No-Gas assignments or units selection from the front panel. This has the same effect as the LOCK/SETUP switch on the back panel of the RS232 module.

This command is "FI<cr>". The response is an "A" followed by a "<cr>".

11. Enable a local operator to make the changes inhibited by the previous command. Except that the local operator will not be able to make these changes if the rear panel inhibit switch is activated.

This command is "FE<cr>". The response is an "A: followed by a "<cr>".



12. Change the stations being displayed on the front panel.

This function can be overridden by a local operator. The commands are "DLx<cr>" to control the left hand display, the "DRx<cr>" to control the right hand display. "x" is the number of the station to be displayed. The response to this command is an "A" followed by a "<cr>".

13. Have the Modular unit perform self-diagnostics, and report the results.

The command for this is "DI<cr>". The typical form of the response is "P15L N12H...", where "P15L" means that the plus fifteen volt supply is low, and "N12H" means that the negative twelve volt supply is high (absolute). If there are not faults, the response is "NO-ERR".

14. Initiate Leak Rate testing.

The command for this is "LR<cr>". The results are the same as pressing the front panel "leak rate" pushbutton. Whenever this command is issued, the leak rate test starts at time "zero". This command can be used for resetting the test to time "zero", if the test is already in progress. The front panel responds the same as if the front panel push button had been pressed, that is, the right hand display shows the leak rate values. The response to this command is an "A" to acknowledge receipt followed by a "<cr>". Leak rate tests always use station #1 as the sensor.

15. Periodically obtain Leak Rate readings.

This command "RL<cr>" causes the modular unit to periodically output the leak rate reading. The data is in the form of four digits, which include any lead zeros, followed by a carriage return like "0015<cr>". The four digits give the leak rate in microns per hour (the same as displayed on the front panel). The data is outputted once every second (regardless of the setup of the modular unit). The initial response to this command is an "A" followed by a "<cr>".

16. End Leak Rate data output.

This command "ED<cr>" halts the output of leak rate data to the RS232 interface, but does not stop the leak rate test. It can be used when it is desired to momentarily interrupt the data flow, without interrupting the test itself, so that other commands could be exercised. The front panel continues to display the leak rate test results (updated once each second). The response to this command is an "A" followed by a "<cr>".

17. End the leak rate test.

This command "EL<cr>" causes the leak rate test to cease, the same as the front panel push button would do if pressed while the leak rate test is in progress. The response to this command is an "A" followed by a "<cr>".



18. Assign a station to operate with "Gas".

The command is "GNx<cr>", where "x" is the station to be switched to have its response calibrated for gas. This command is different from assigning "Gas" from the front panel in that it does not matter whether or not the station is being displayed in the right hand display. (In order for a station to be selected for "Gas" operation by way of the front panel push button, the station must be displayed in the right hand display). The response to this command is an "A" followed by a "<cr>".

19. Remove a station from "Gas" operation.

This command is "GFx<cr>". Once again the "x" is the station number of the station being removed from operation with "Gas". The operation is the reverse of "GNx<cr>" above. The response to this command is an "A" followed by a "<cr>".

20. Change the "Units" in which the Modular unit is displaying readings.

There are three separate commands for this function:

"UM<cr>" causes both displays to display in millibars.

"UP<cr>" causes both displays to display in Pascals.

"UT<cr>" causes stations to be displayed in Televac traditional units. For example a cold cathode station would be displayed in Torr, a thermocouple unit would be displayed in either Torr or microns, depending upon the magnitude of the pressure.

21. Fetch the ON setting of set-point "x".

This command is "SPxN<cr>", where "x" is the PCR number for which it is pressure setting at which the PCR will operate (energize). The response to this command is a four digit number including lead zeros followed by a "<cr>".

22. Fetch the OFF setting of set-point "x".

This command is "SPxF<cr>", where "x" is the PCR number for which it is desired to find out the pressure setting at which the PCR will drop-out (de-energize). The response to this command is a four-digit number followed by a "<cr>".

23. Adjust the ON setting of set-point "x".

This command is "SSxNyyyy<cr>", where "x" is the PCR number for which it is desired to set the operate (energize) point, and "yyyy" is the setting. Lead zeros, if any, must be sent. The setting will be in microns for a thermocouple type gage, and will be in steps of 10E-6 for cold cathode gages. The response to this command is an "A" followed by a "<cr>".



24. Adjust the OFF setting of set-point "x".

This command is "SSxFyyyy<cr>", where "x" is the PCR number for which it is desired to set the dropout (de-energize) point, and "yyyy" is the setting. Lead zeros, if any, must be sent. The setting will be in microns for a thermocouple type gage, and will be in steps of 10E-6 for cold cathode gages. The response to this command is an "A" followed by a "<cr>".

25. Fetch the modular unit software version.

This command is "SV<cr>". The modular unit responds with "Ver n.nn<cr>", where n.nn is the version number.

26. Change the baud rate for the RS232C interface.

This command is "SBI l<cr>". "l" is a letter that is repeated for redundancy sake. The baud rate changes according to the following table:

AA	300 baud
BB	600 "
CC	1200 "
DD	2400 "
EE	4800 "
FF	9600 "

The modular unit responds with an "A", and a "<cr>" prior to changing it's baud rate. Any further communications must be performed at the new baud rate. (See also #26).

27. Store all default values.

This command is "SE<cr>". When the baud rate is changed by the command given above, this command should be given at the new baud rate, if it is desired for the modular unit to be at the new baud rate after power has been removed and re-applied. Also, it should be noted that the UNITS displayed when this command is given will be the default values and will be those displayed after the next power off/on cycle. The response to this command is an "A" followed by a

NOTE: All commands that do not require a response otherwise respond with an "A" and a carriage return if properly recognized. Whenever any command is not properly recognized, the Modular unit will respond with a question mark, "?" followed by a carriage return. All other command responses end with a carriage return.



COMMAND	RESPONSE
Annn<cr>	Output each marked station value every nnn cycles, where nnn is any value between 1 and 255. (in Torr or microns).
AR<cr>	Outputs relay configuration.
CA<cr>	Cancel the automatic output.
DI<cr>	Modular unit performs internal diagnostics. Faults will be reported as "P5L0...". If no faults "NO ERRORS".
DLx<cr>	Station x is displayed on the left side.
DRx<cr>	Station x is displayed on the right side.
ED<cr>	End Leak Rate data stream (but not test).
EL<cr>	Ends Leak Rate test.
FA<cr>	Inhibits most front panel functions.
FE<cr>	Enables certain front panel functions, unless inhibited by the rear panel switch.
FI<cr>	Inhibits certain front panel functions.
GNx<cr>	Sets Station x for gas operation.
GFx<cr>	Clears Station x from gas operation.
LR<cr>	Starts Leak Rate test. Time = 0.
Mx<cr>	Mark station x, where x is any number between 1 and 9, or A for Station 10.
RL<cr>	Read Leak Rate value periodically. "LR-nnnn" where nnnn is the leak rate in microns/hr.
Rx<cr>	One shot reading of station x.
SB11<cr>	Set baud rate. (See Table).
SE<cr>	Store entries.
Sx<cr>	Returns processor type installed in Station x.
SAxSy	Assign set-point x to station y.
SPx<cr>	Send the station assignment of set-point x.
SPxN<cr>	Send the set-point "ON" setting of set-point x.
SPxF<cr>	Send the set-point "OFF" setting of set-point x.
SSxNyyyyL<cr>	Set set-point #x "ON" at yyyy - Low range. **
SSxNyyyyH<cr>	Set set-point #x "ON" at yyyy - High range. **
SSxFyyyyL<cr>	Set set-point #x "OFF" at yyyy - Low range. **
SSxFyyyyH<cr>	Set set-point #x "OFF" at yyyy - High range. **
SV<cr>	Send software version.
UM<cr>	Causes Stations to be displayed in millibars.*
UP<cr>	Causes Stations to be displayed in Pascals.*
UT<cr>	Causes stations to display in traditional units.
Ux<cr>	Unmark station #x form automatic output.



\* Changes display only. Does not change UNITS of RS232 output data or UNITS of "0-10V" output data.

\*\* Low and high range as noted below.

SENSOR	UNITS	RANGE	RS232 SETTING / READING
2A	MICRONS	1 - 1000	0001L to 0999L
	TORR	1.0 – 20.0	0010H to 0200H
4A	MICRONS	1 - 1000	0001L to 0999L
	TORR	1 - 1000	0001H to 0999H
1E	TORR	1 - 1000	0001L to 0999L
7B	TORR	1.0E <sup>-6</sup> to 2.0E <sup>-3</sup>	0001H to 2000H
7E	TORR	1.0E <sup>-8</sup> to 9.9E <sup>-6</sup>	0001L to 0999L
	TORR	1.0E <sup>-5</sup> to 9.9E <sup>-3</sup>	0010H to 0999H



**RS232  
 HARDWARE**

The MM200 uses a DE9S connector (female) for RS232 and the RS485 hardware interface. The pinouts are in accordance with Fig. 6.1 and Table 6.1.

PIN	FUNCTION
2	Tx - from MM200
3	Rx - to MM200
4	DTR - to MM200
5	GROUND
6	DSR - TO MM200
7	DO NOT USE
8	DO NOT USE

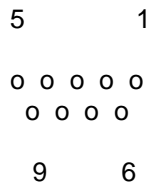

**SPECIAL COMMANDS**

The following commands are for factory and servicing use, and are not for publication. They require use of the password.

CDxx,yy<cr>	Change RAM byte @xxH to yyH.
CN<cr>	Change from "cal" to normal unit (can be stored).
CP<cr>	Clear password.
CU<cr>	Change from normal to "cal" unit (can be stored).
DF<cr>	Turn "off" the watchdog.
DN<cr>	Turn "on" the watchdog.
EP<cr>	Enter password.
RCnnnn<cr>	Read code starting at nnnnH.
RD<cr>	Read MPU RAM.
SF<cr>	Show the fault displays (one time each).





## 700 CALIBRATION

### 701 ELECTRICAL "VERIFICATION" OF VACUUM MEASURING INSTRUMENTS ON VACUUM CHAMBERS

An electrical "verification" of a Televac vacuum measuring instrument provides a way to assure that the vacuum measuring instrument installed on the vacuum chamber is in electrical agreement with Televac's "standard" gauges. Our "standard" gauges are directly traceable to NIST.

Electrical agreement with Televac's "standard" gauges is accomplished through the use of an electronic gauge tube simulator, which is substituted in place of the gauge tube installed on the vacuum chamber. Such "verification" does not in itself assure that the vacuum measured in the chamber is correct, since the gauge tube installed on the vacuum chamber is bypassed. It does give an electrical check of the vacuum measuring instrument and cable.

## EQUIPMENT REQUIRED

In order to use the Field Procedure the following equipment is required.

### A. Vacuum Chamber Equipment

Each vacuum furnace should be fitted with an instrument with special features.

1. A "zero adjust" (or "heater adjust") calibration potentiometer for each thermocouple gauge, located on the rear panel.
2. A  $10^{-3}$  Torr calibration adjust potentiometer for the cold cathode, located on the rear panel.
3. Cold cathode gauge tubes of the latest improved design. (Dual magnet type). Retrofit existing tubes or replace, if necessary.

### B. Electrical Gauge Tube Simulators

The devices used to carry out electrical "verification" of the modular vacuum instruments are referred to as gauge tube simulators. These devices can be returned to the Televac factory annually to be recertified. They are listed below.

- 2-2100-93 Cold cathode tube simulator ( $10^{-3}$ ,  $10^{-5}$  Torr)
- 2-2100-237 2A tube simulator (Set at "Redline")
- 2-2120-000 4A tube simulator (Set at "Redline")

**PROCEDURE FOR ON-SITE ELECTRICAL "VERIFICATION" OF TELEVAC MODULAR MM200 INSTRUMENTS**

1. Install the proper cold cathode and/or the thermocouple gauge tube simulators at the end of their respective cables. Use the  $10^{-3}$  Torr connection for the cold cathode gauge tube simulator.

Observe the meter readings.

2. If the meter does not read, " 0.0" ("redline"), on the thermocouple stations of the modular MM200 instrument, adjust the "zero adjust" ("heater adjust") potentiometer to bring the reading to " 0.0". (Set at the point where display switches from "- 0.0" to " 0.0".

Replace the installed thermocouple gauge tube with a new gauge tube to be sure that the gauge tube is not degraded by contamination.

3. On the cold cathode station of the modular MM200 instrument, observe that the readings fall between  $8 \times 10^{-4}$  and  $2 \times 10^{-3}$  Torr.

Minor adjustment of the reading can be made to show agreement with the gauge tube simulator. To do this, adjust the cold cathode  $10^{-3}$  potentiometer to give a reading of  $1 \times 10^{-3}$  Torr.

Clean the gauge tube body and clean or replace the anode assembly.

4. Place an electrical "verification" sticker on instrument.



## 702 VACUUM CALIBRATION OF VACUUM MEASURING INSTRUMENTS ON VACUUM CHAMBERS

A Televac instrument with tubes and cables will be given an NIST traceable calibration and so certified by Televac. This instrument will be used as a "master gauge" for re-calibration of the installed vacuum gauges on a periodic basis.

[When practical, the master gauge can be used as a spare in an emergency to assure continuity of production.]

### EQUIPMENT REQUIRED

In order to use the On-site Calibration Procedure, the following equipment is required.

#### A. Vacuum Chamber Equipment

Each vacuum chamber should be fitted with an instrument with special features. The MM200 meets these requirements.

1. A "zero adjust" ("heater adjust") calibration potentiometer for the thermocouple gauge(s), located on the rear panel.
2. A  $10^{-3}$  Torr calibration potentiometer for the cold cathode gauge(s), located on the rear panel.
3. Cold cathode gauge tubes of the latest improved design. (Retrofit existing tubes to the dual magnet configuration or replace, if necessary.)

#### B. Master Gauge

A master gauge is an instrument with the same features as above. This gauge will have one cold cathode gauge tube with a 50' cable and at least one thermocouple gauge tube with a 50' cable. The instrument, tubes and cables will have NIST traceable calibration performed by Televac for the cold cathode station and for thermocouple station(s)

This master gauge with its tubes and cables should be returned to Televac annually for an NIST traceable calibration. When external calibration potentiometers are provided they must be sealed after the calibration is completed.



## PROCEDURE FOR ON-SITE VACUUM CALIBRATION OF TELEVAC MODULAR MM200 INSTRUMENTS

1. Install the master gauge tubes on the vacuum chamber in a location, which will allow the master gauge tubes and the vacuum chamber gauge tubes to see the same pressure under static test conditions. To achieve this, we recommend that a "T" be installed on each vacuum chamber. (See figures).
2. Pump the chamber down to a pressure of less than  $10^{-4}$  Torr.
3. On the main chamber thermocouple gauge (usually TC#1), adjust the "zero adjust" ("heater adjust") potentiometer to bring its reading into agreement with the master gauge TC#1. It should read at " 0.0" ("red line") on the MM200 instrument.
4. Close the main valve. Slowly bleed dry nitrogen into the chamber until a pressure of 1 micron is observed on the master thermocouple gauge. Observe the gauges for a minimum of 2 minutes. Leak up should be minimal before proceeding. If not, determine the source of the leak and correct it.
5. Check the thermocouple readings at 1, 10 & 150 microns. Under the conditions of field test, at the vacuum chamber, the following tolerances should be observed:

1	±	1 micron
10	±	2 microns
150	±	30 microns

Record the data. Readjust, if required, and record new data.

6. With the pressure at 1 micron ( $10^{-3}$  Torr ), observe that the readings on the cold cathode gauge of the vacuum chamber instrument, fall between  $8 \times 10^{-4}$  and  $3 \times 10^{-3}$  Torr.

Minor adjustment of the gauge can be made to show agreement with the thermocouple gauge at 1 micron. In order to do this, adjust the cold cathode " $10^{-3}$ " potentiometer to give a meter reading of  $1 \times 10^{-3}$  Torr.

Record data.

7. Place calibration sticker on instrument.
8. Remove the master gauges from the vacuum chamber and replace the plugs in each calibration "T".

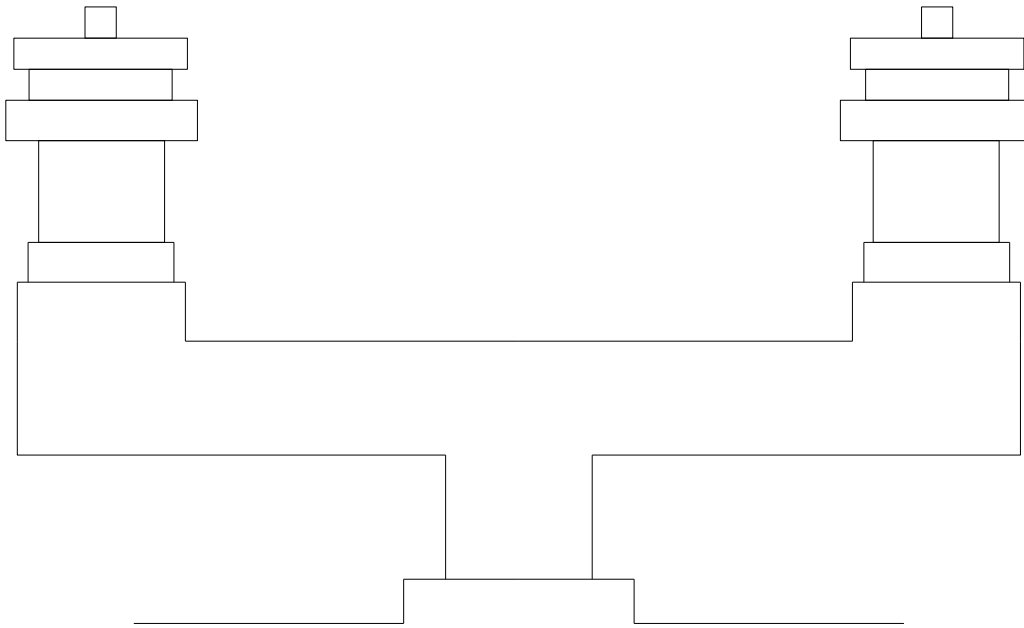

Fig.7.1 - Vacuum Chamber "T" for Installing Gauge Tubes

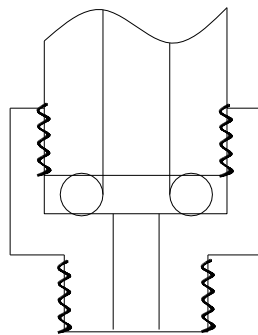
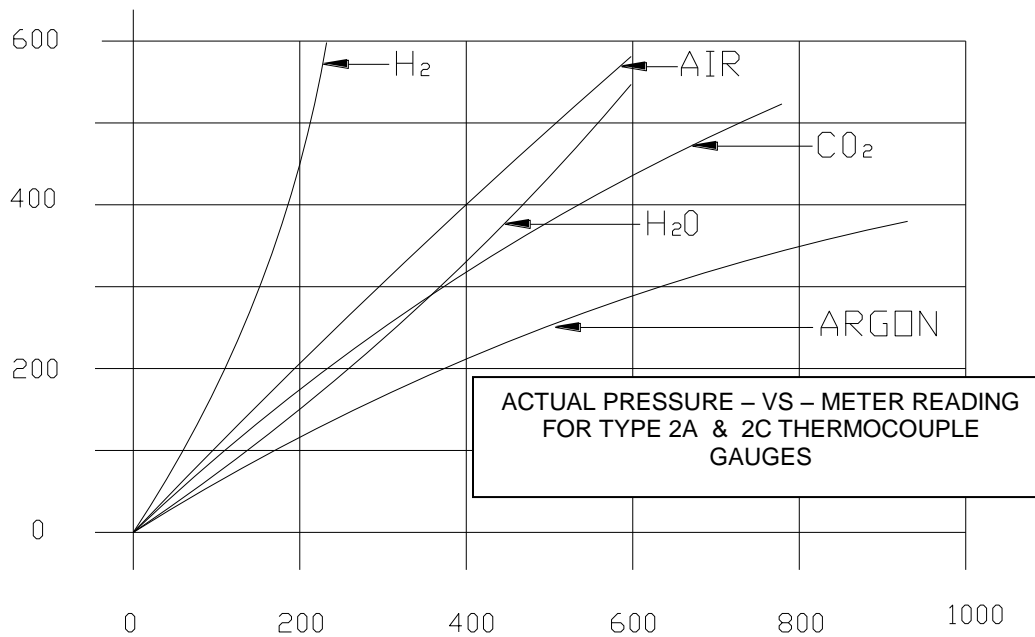

Fig. 7.2 - Adapter



**703 CALIBRATION OF VACUUM MEASURING INSTRUMENTS FOR ALTERNATE GASSES**

All thermal conductivity gauges, such as thermocouple gauges, are gas dependent. That is, their response depends on the gas being measured. These gauges are calibrated for nitrogen or air. Their response to other gasses is shown in Fig. 7.3.



ACTUAL PRESSURE – McCLEOD GAUGE (microns Hg.)

Fig. 7.3 - Actual Pressure -vs- Meter Reading



**800 SPECIFICATIONS**

**801 CONTROLLER SPECIFICATIONS**

- » Indoor use
- » Attitude up to 2000 m
- » Temperature 5° C to 40° C
- » Maximum relative humidity 80% for temperatures up to 31° C decreasing linearly to 50 % relative humidity at 40° C
- » Overvoltage category - category II of IEC 60364-4-443
- » Rated pollution degree: 2
- » Voltage 115/230 VAC ±10%
- » Frequency 50 - 60 Hz.
- » Input Current (Max.)  
 2A @ 115V  
 1A @ 230V
- » Input Power (Max.)  
 230W
- » Calibration medium Dry Air, (or Nitrogen)
- » Oper. temp. (tube) 0 to 65°C
- » Setpoint Relays Assignable to any station 5A 120 VAC or dry circuit
- » Output Analog 0-10 VDC
- » Weight (instrument) 5 lbs.

**802 CONTROLLER DIMENSIONS**

The controller dimensions and cut out dimensions are given in Figure 8.1

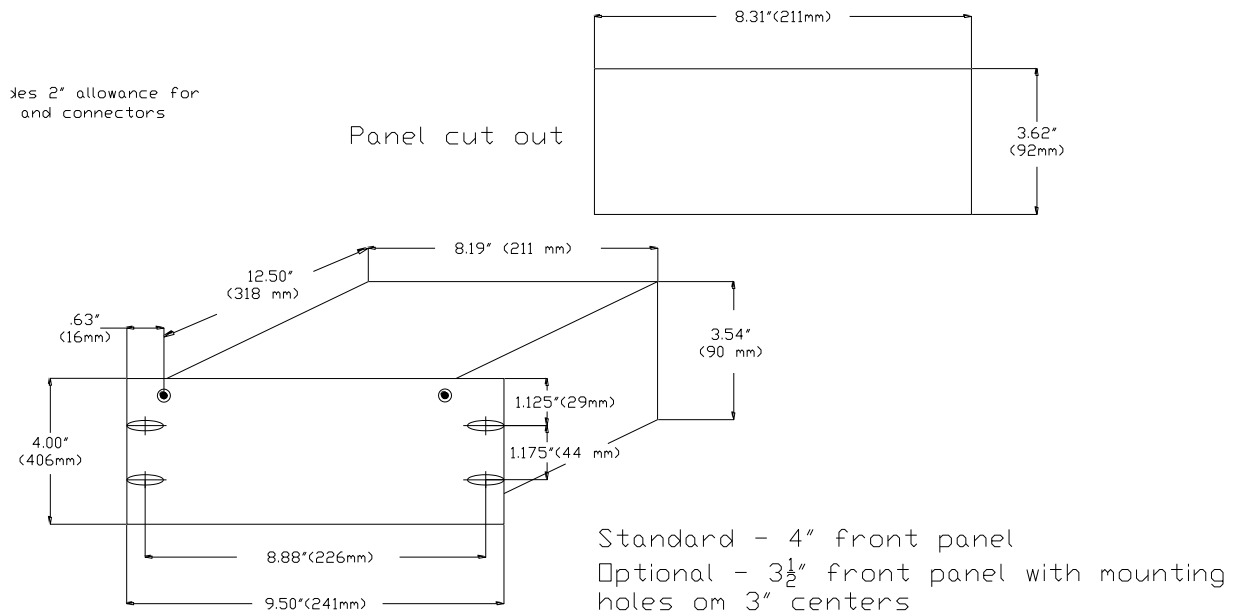

Fig. 8.1 - Dimensions for Modular Gauge



### 803 SENSORS

Specifications for the various sensors (gauge tubes) are listed in Tables 3.2 and 4.1.

### 804 ORDERING INFORMATION

Modular gauges may be assembled by combining several modules to form the desired multi-functional gauge. Select the desired modules and build the model number of the gauge as shown in the example below. Typically, setpoint relay modules are inserted first, starting from left to right, then thermocouple gauges are installed from left to right. Finally, cold cathode gauges from right to left. Blank panels are used if there is less than a full complement of modules. In the analog versions, the types of modules are limited by the markings on the meter (s) installed; whereas in the digital gauge no limitations exist.

#### AVAILABLE MODULES: Can be placed in any of slots 1 through 6

TC = THERMOCOUPLE

2A = Two station 2A

7E = One station 7E

CV = CONVECTION

4A = Two station 4A

DI = DIAPHRAGM

1E = Two station 1E

3E = Hot cathode (EB degas)

CC = COLD CATHODE

7B = One station 7B2

7F = One station 7F

HC = HOT CATHODE

3D = Hot cathode (I<sup>2</sup>R degas)

S = SETPOINT RELAY

R = DIGITAL INT.

S = 4 @ 5 Amp, 120VAC

R = RS232 / RS485 (SLOT 7)

B = BLANK PANELS

B1 = Full blank

B2 = 1/2 blank

#### FUTURE OPTIONS:

Capacitance Diaphragm Gauge (CDG), Flow Meter





EXPANSION SLOT

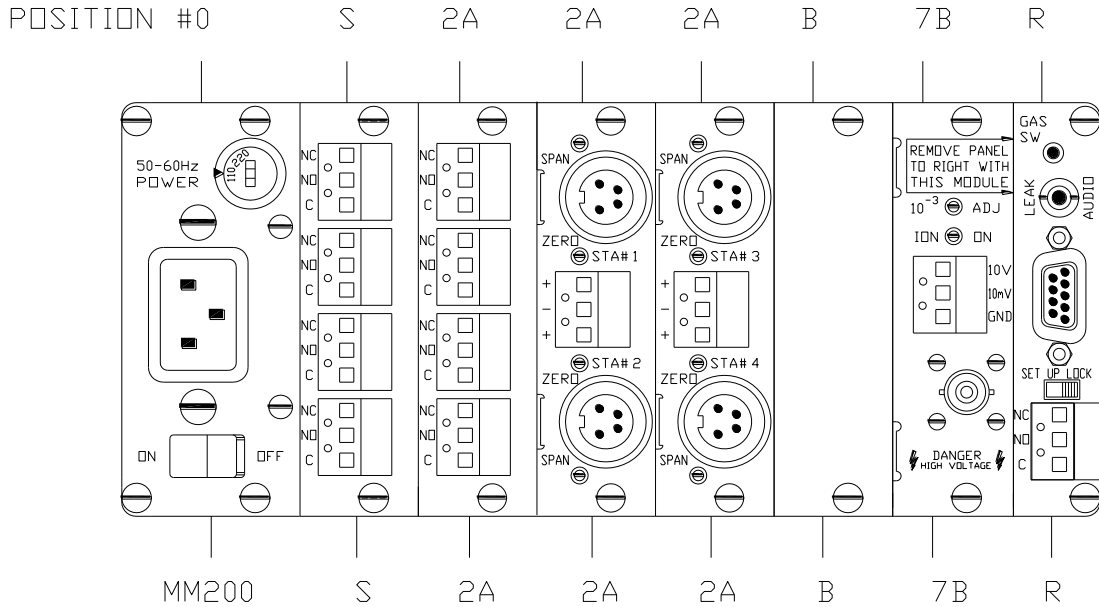

MM200 - Microprocessor with power supply,  
4 relays, 7 stations and RS232:

- SLOT 1: S - 4 relay module (5 amp, 120VAC)
- SLOT 2: 2A - Dual thermocouple module (2 stations)
- SLOT 3: 2A - Dual thermocouple module (2 stations)
- SLOT 4: 2A - Dual thermocouple module (2 stations)
- SLOT 5: B1 - Blank panel
- SLOT 6: 7B - Single cold cathode module (1 station)
- SLOT 7: R - RS232 / RS485 module (no stations)

NOTES:

1. SLOT 0 contains the power supply module
2. SLOT 7 has a blank panel for ANALOG gauges and can have an RS232 / RS485 module for the microprocessor based DIGITAL gauge



## 900 TROUBLESHOOTING

### 901 PRELIMINARY TROUBLESHOOTING

Refer to prior sections of the manual for preliminary troubleshooting help in accordance with Table 9.1.

Table 9.1

200	Initial checkout
300	Installation
400	Operation
500	Programming
600	Communications
700	Calibration
800	Specifications

Next are some possible problems and the suggested solutions.

- P - All displays are blank.
- S - Check power switch, power source and power cable.
  
- P - Ion gauge reads "OFF" and controlling TC reads 20.0 Torr and is flashing.
- S - Normal. Pressure is above the ion-on setting of 10 microns and the controlling (chamber) TC is above 20.0 Torr.
  
- P - Ion gauge reads "OFF" and Ion-on source TC reads above 10 microns.
- S - Normal. Pressure is above the ion-on setting of 10 microns.
  
- P - Display shows readings other than pressure.
- S - Press TEST/OP. If MICRONS PER HOUR is lighted, press LEAK RT pushbutton.



902 SETUP OF MODULE BOARDS

The module boards are preset at the Televac factory. However, if you wish to change them, first remove them from the MM200 in accordance with the instructions in Section 308.

**SETPOINT RELAY MODULE** - A setpoint process control relay module is shown in Fig. 9.1a. The assignment of identification numbers for this module (usually done at the factory) is accomplished by placing jumpers on the appropriate pins in the SETPOINT ID section of the module. Note that two (2) sets of jumpers are required. The SIGNAL SOURCE section is used for the MM200 and jumpers should be installed in all four MP locations. Switches S1 through S4 should be set in the "MP" (or upper) position. See Fig. 9.1b for details.

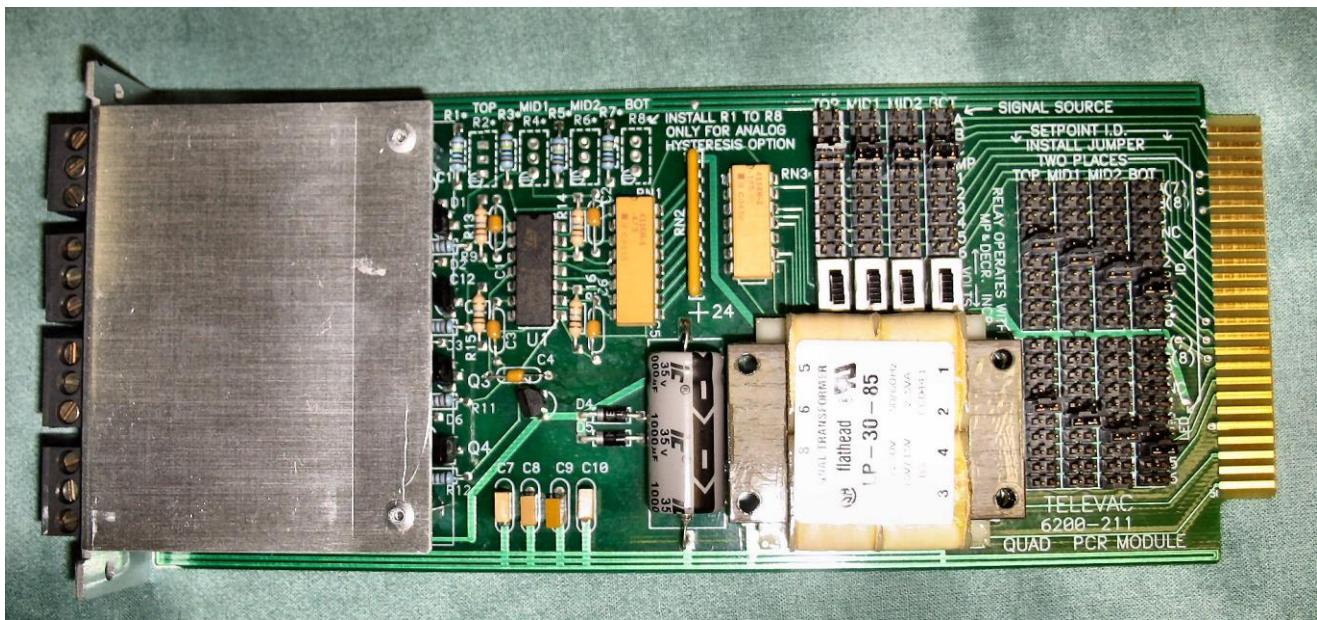

Fig. 9.1a - Setpoint Relay Module



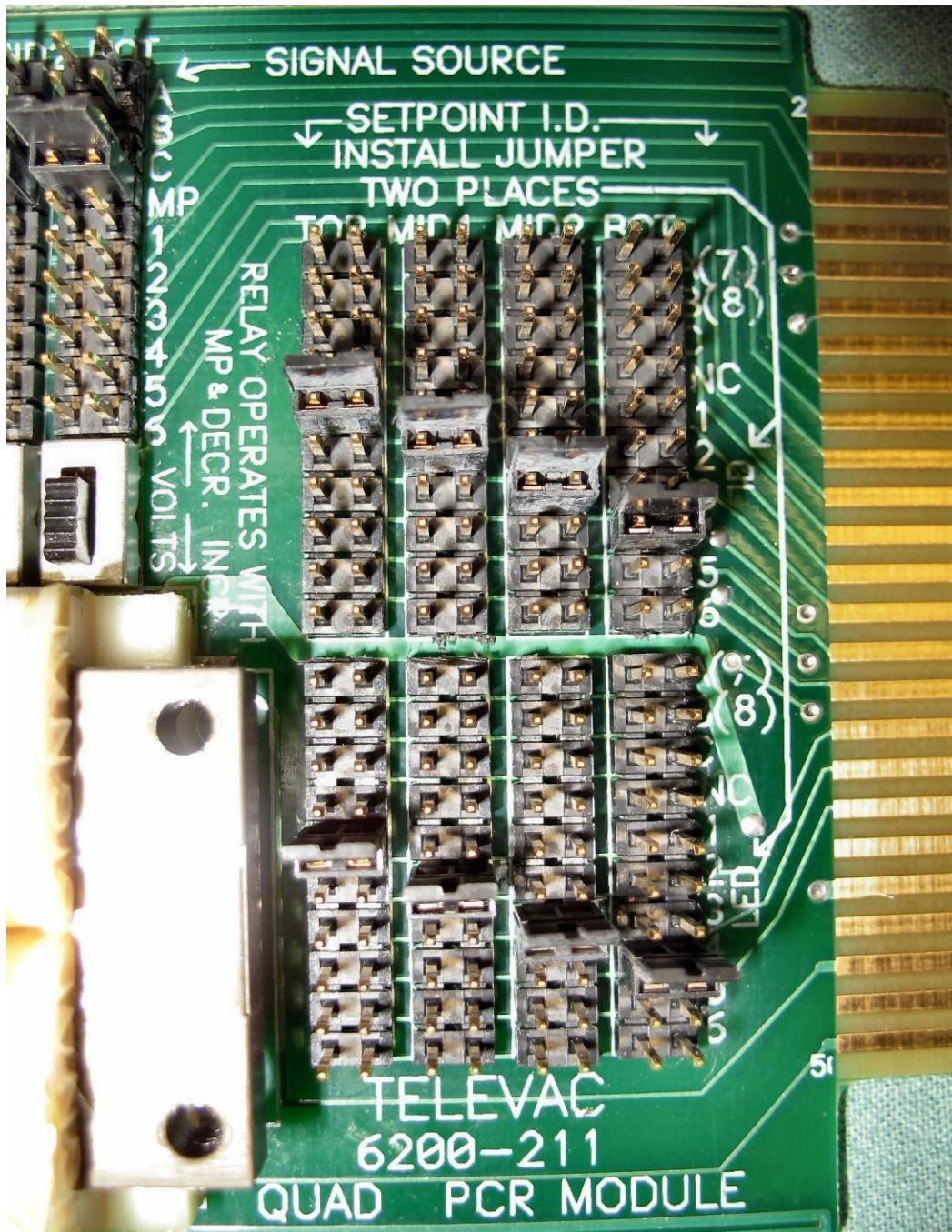

Fig. 9.1b - Details of the Setpoint Relay Module



**DIGITAL INTERFACE MODULE** - A digital interface module is shown in Fig. 9.2. When a cold cathode module is installed in expansion slot #6, it must be removed before the digital interface module can be installed. Note that there is a cutout in the digital interface module to clear the transformer of the cold cathode module. These two modules must be installed at the same time.

RSS485 allows a string of MM200s to be linked. It is important to terminate the last unit on the string. This is done by placing a jumper across J6 (TERM) in the lower left hand side of the board. This termination is designed for 120  $\pm$  ohm twisted pair cable. If another value (such as 220 ohm) cable is used, change the value of R2 from 121 ohms to the appropriate value.

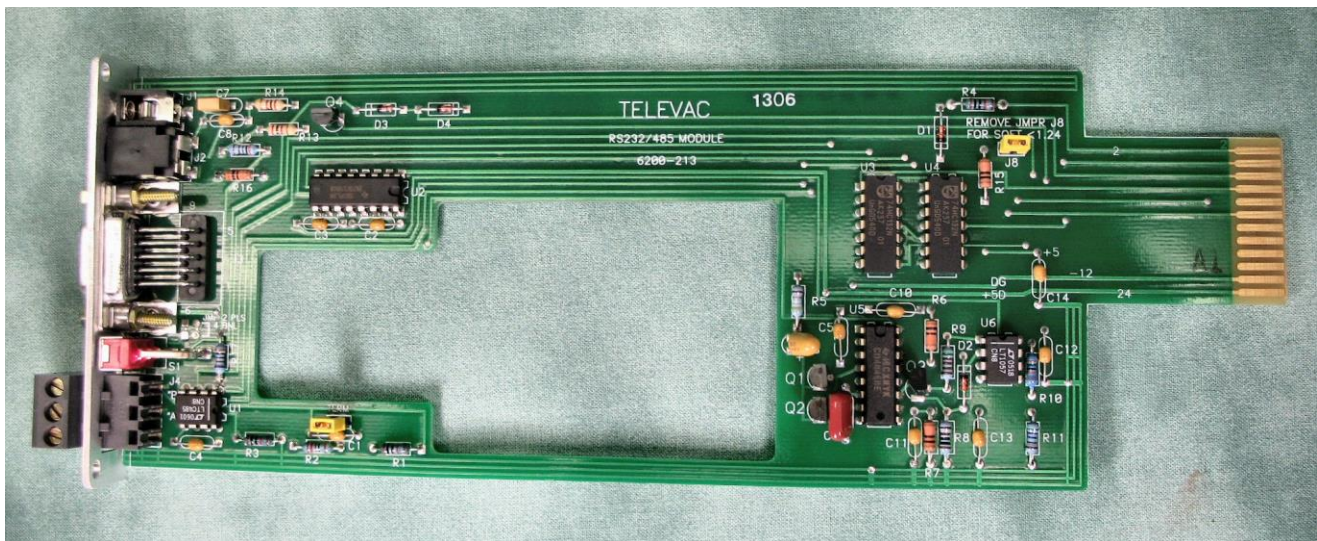

Fig. 9.2 – Digital Interface Module





**THERMOCOUPLE MODULE** - A thermocouple module is shown in Fig. 9.3a and 9.3b. This module is typical of all modules. The assignment of station identification numbers on a thermocouple module is accomplished by placing jumpers across the appropriate pins in the SIGNAL ID and the REC OUT ID sections. The upper thermocouple station has been named station #3 and the lower thermocouple station has been named station #4. Also two (2) jumpers are placed in the "MP" positions of the ANALOG/MP section of the board.

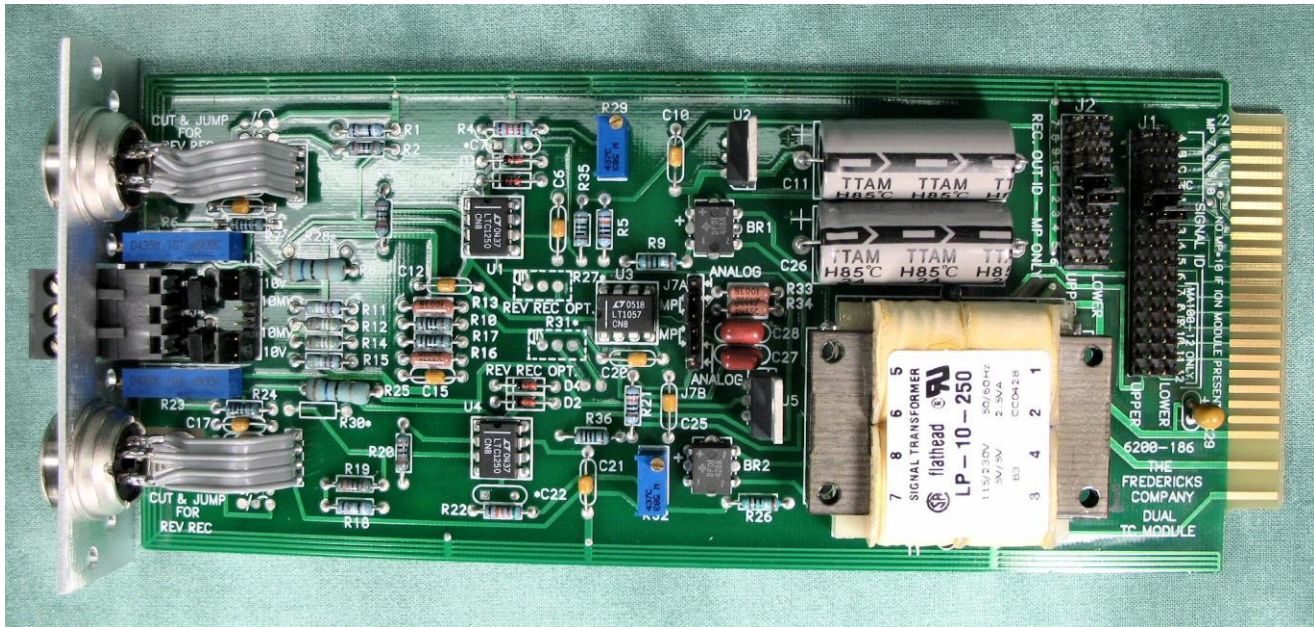

Fig. 9.3a - Thermocouple Module



Finally, there are jumpers placed in the 10V position of J3. This provides a 0 to 10VDC analog "0-10V " output. The alternate is a 0 to 10 mV output. This not recommended unless your recorder cannot handle 10V.

Labels are placed on the rear panel to show the station names assigned.

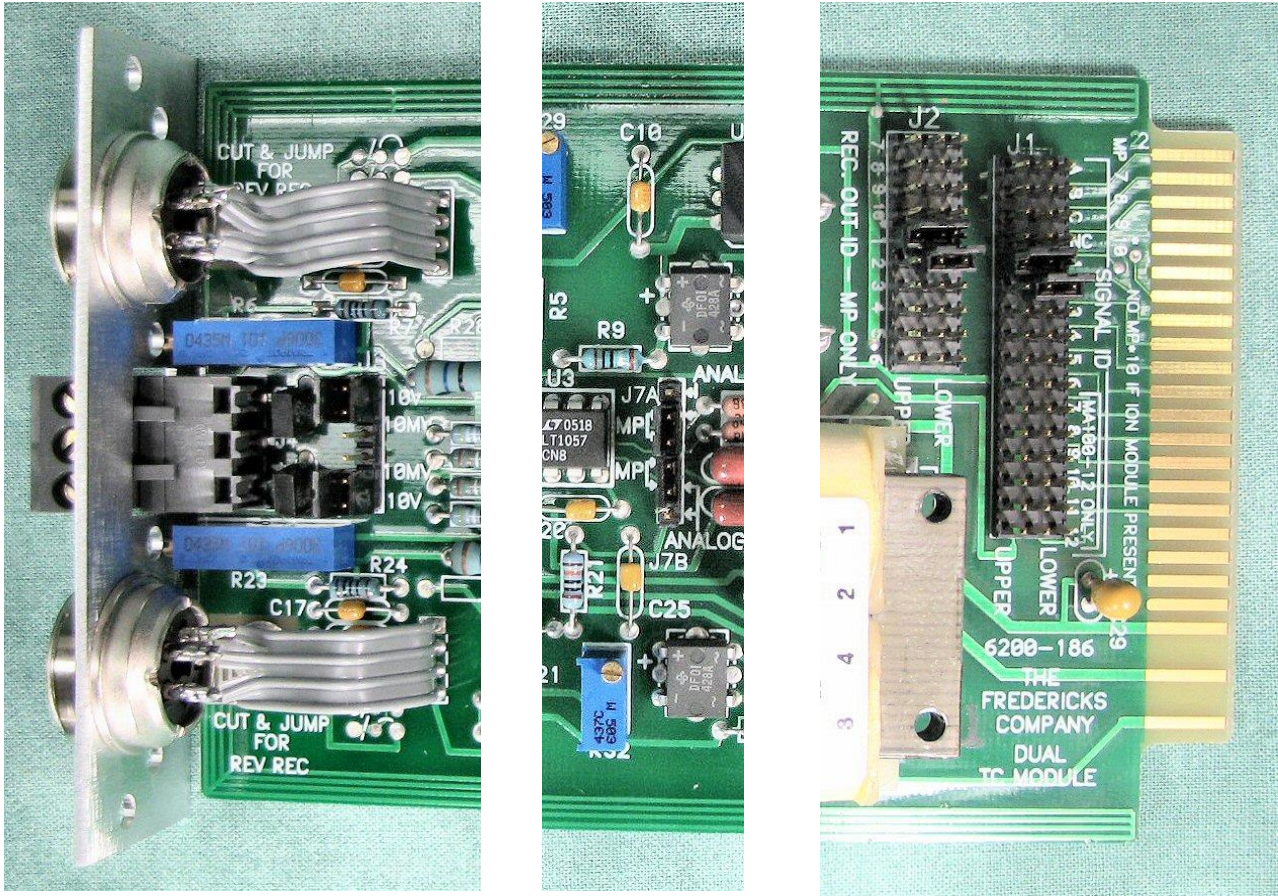

Fig. 9.3b - Thermocouple Module Details





**CONVECTION MODULE** - A convection module is shown in Fig. 9.3c and 9.3d. This module is typical of all modules. The assignment of station identification numbers on a convection module is accomplished by placing jumpers across the appropriate pins in the SIGNAL ID and the REC OUT ID sections. The upper convection station has been named station #1 and the lower convection station has been named station #2. Also two (2) jumpers are placed in the "MP" positions of the ANALOG/MP section of the board.

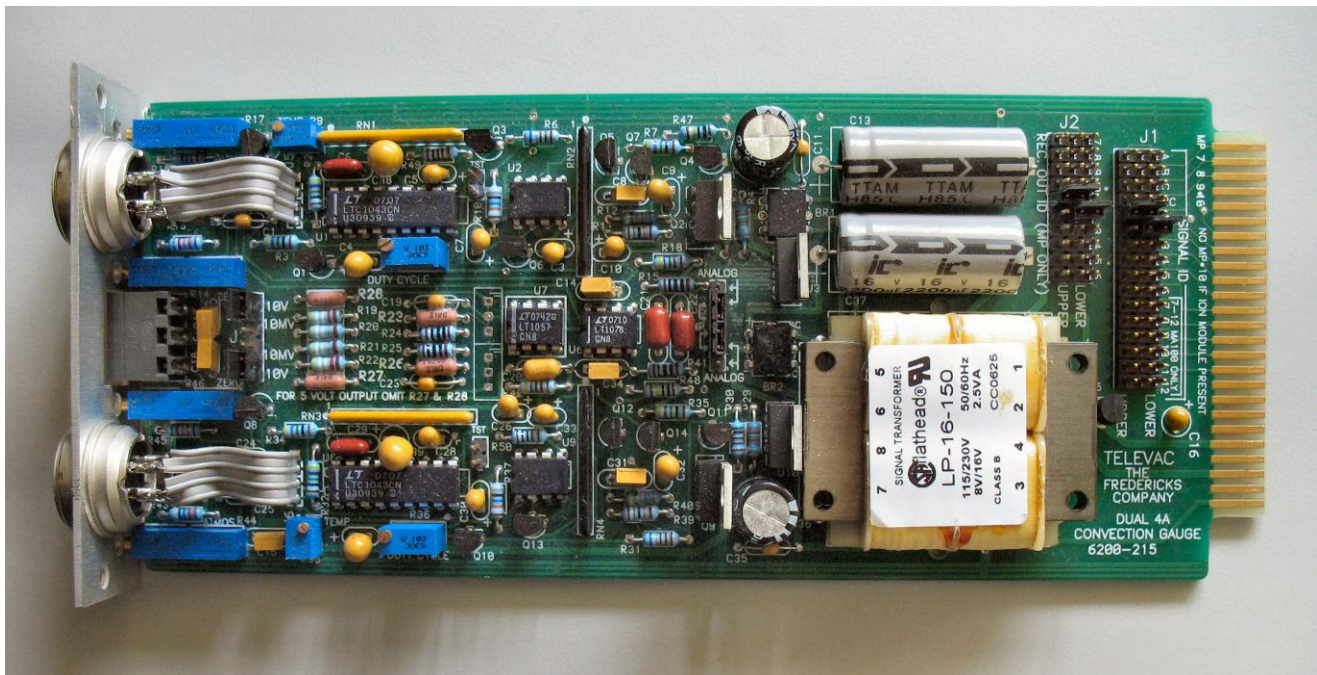

Fig. 9.3c – Dual Convection 4A Gauge Module





Finally, there are jumpers placed in the 10V position of J3. This provides a 0 to 10VDC analog "0-10V " output. The alternate is a 0 to 10 mV output. This is not recommended unless your recorder cannot handle 10V.

Labels are placed on the rear panel to show the station names assigned.

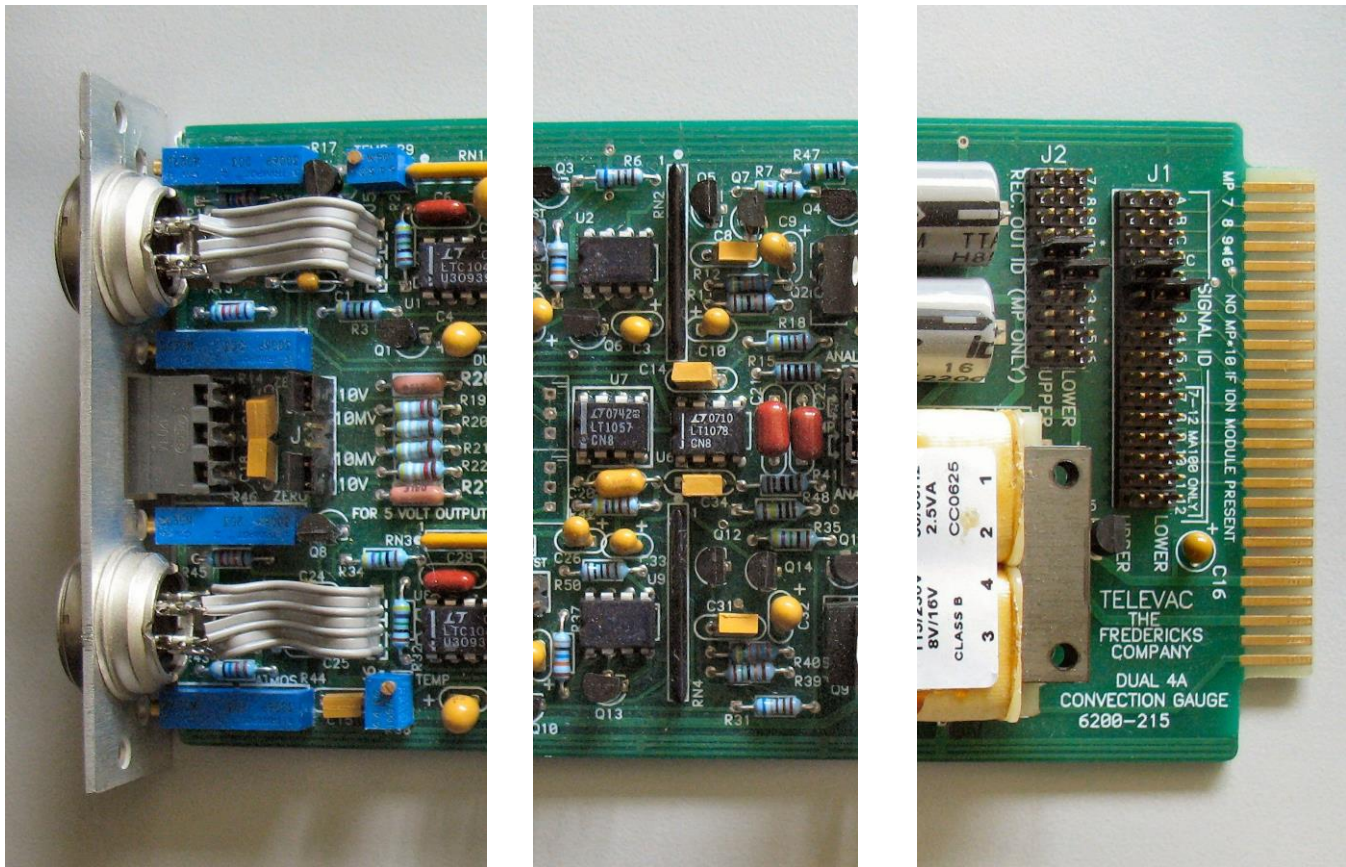
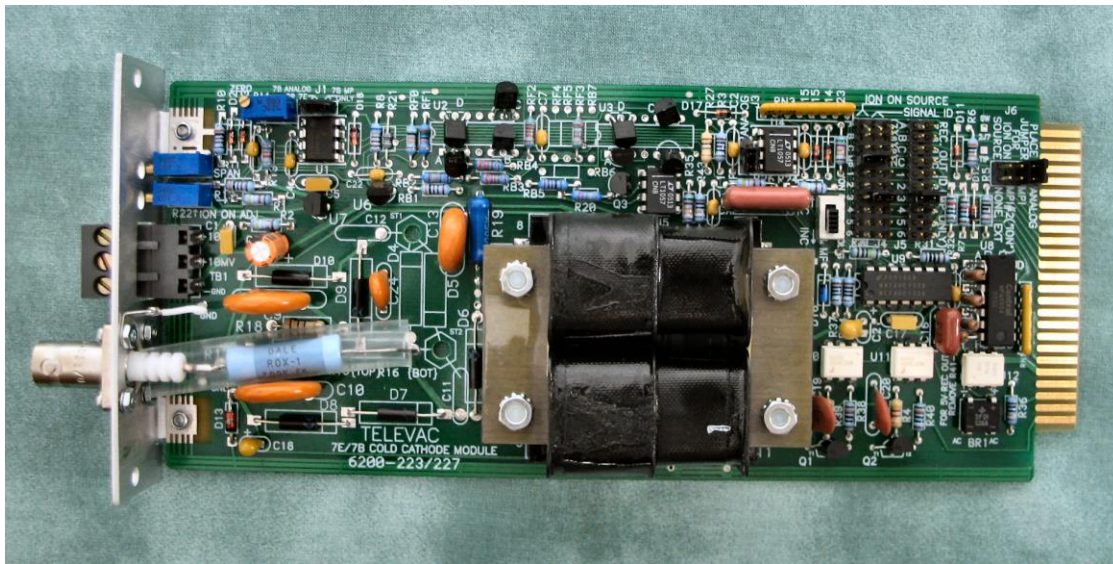

Fig. 9.3d – Dual 4A Convection Gauge Module Details



**CATHODE MODULE** - The cold cathode modules are shown in Fig. 9.4a and 9.4b. Station number is assigned by a jumper in the SIGNAL ID section of the module board (e.g., station #7). A second jumper is placed in the REC OUT section. This must agree with the SIGNAL ID. A third jumper (in the ION-ON SOURCE section of the module) selects the station used as a reference to turn on the cold cathode power (for the MM200 select the MP location). A fourth jumper is placed in the JUMPER 4 ION ON section. Select MPI if only 1 cold cathode is being used or if all cold cathodes are to be turned on using the same reference. Select MPI#2 if the second cold cathode is to be turned on from a different reference than that for the first cold cathode.



2-6200-227  
 with jumpers

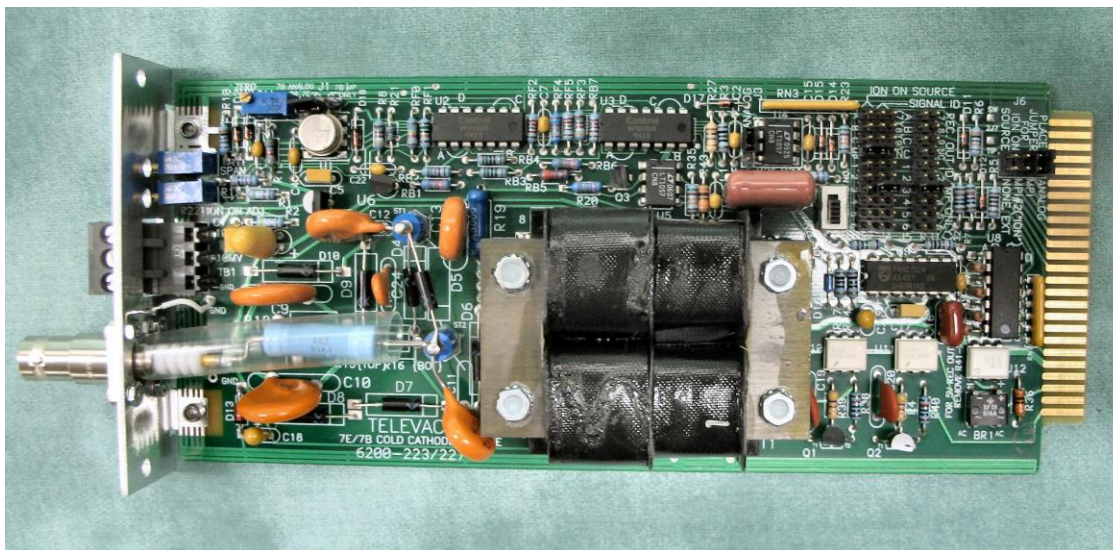

2-6200-223  
 with jumpers

Fig. 9.4a - 7B Cold Cathode Gauge Modules





**CATHODE MODULE** - The cold cathode modules are shown in Fig. 9.4a and 9.4b. Station number is assigned by a jumper in the SIGNAL ID section of the module board (e.g., station #7). A second jumper is placed in the REC OUT section. This must agree with the SIGNAL ID. A third jumper (in the ION-ON SOURCE section of the module) selects the station used as a reference to turn on the cold cathode power (for the MM200 select the MP location). A fourth jumper is placed in the JUMPER 4 ION ON section. Select MPI if only 1 cold cathode is being used or if all cold cathodes are to be turned on using the same reference. Select MPI#2 if the second cold cathode is to be turned on from a different reference than that for the first cold cathode.

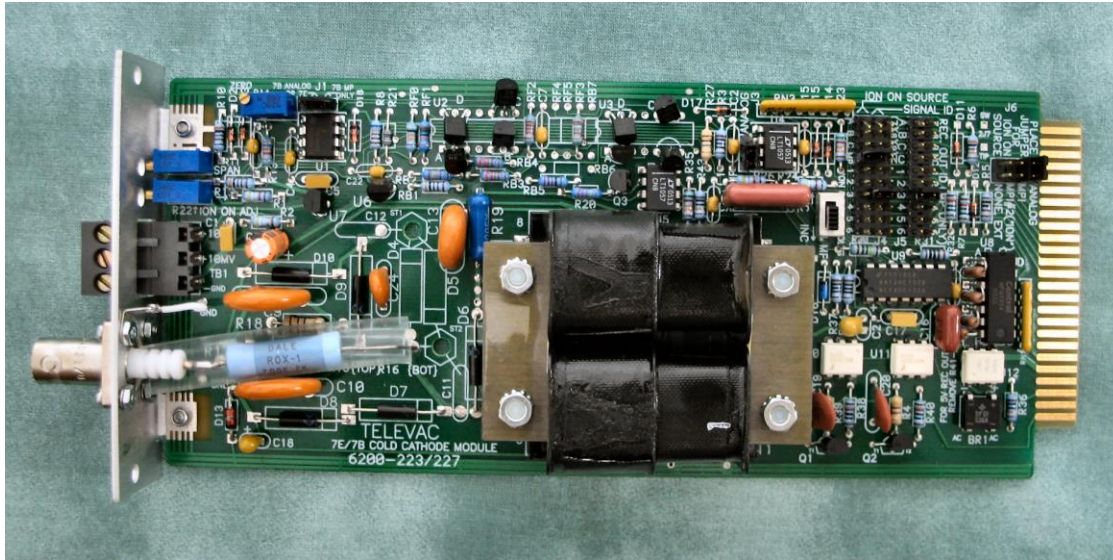

2-6200-227  
with jumpers

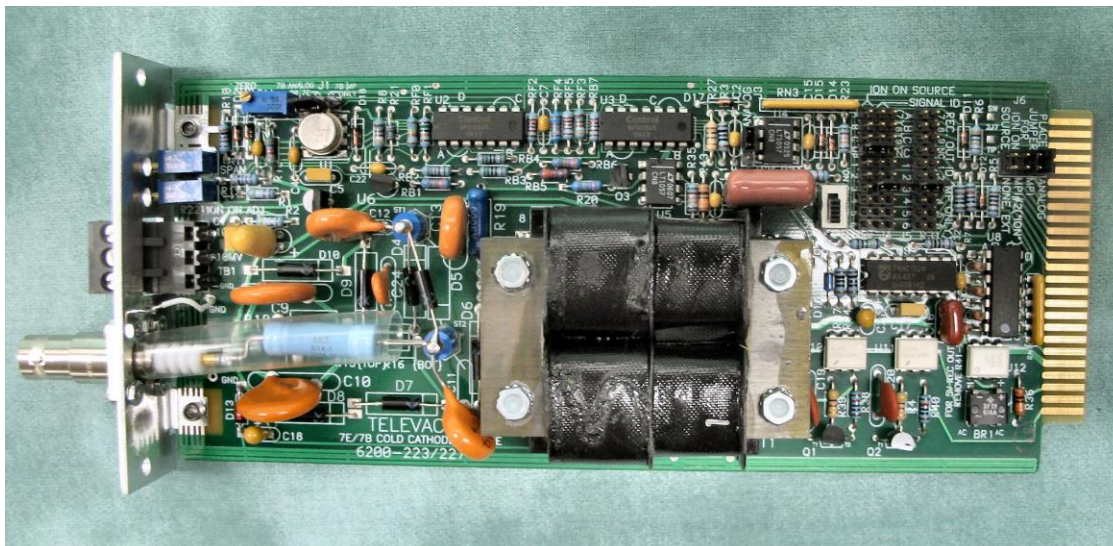

2-6200-223  
with jumpers

Fig. 9.4a - 7B Cold Cathode Gauge Modules

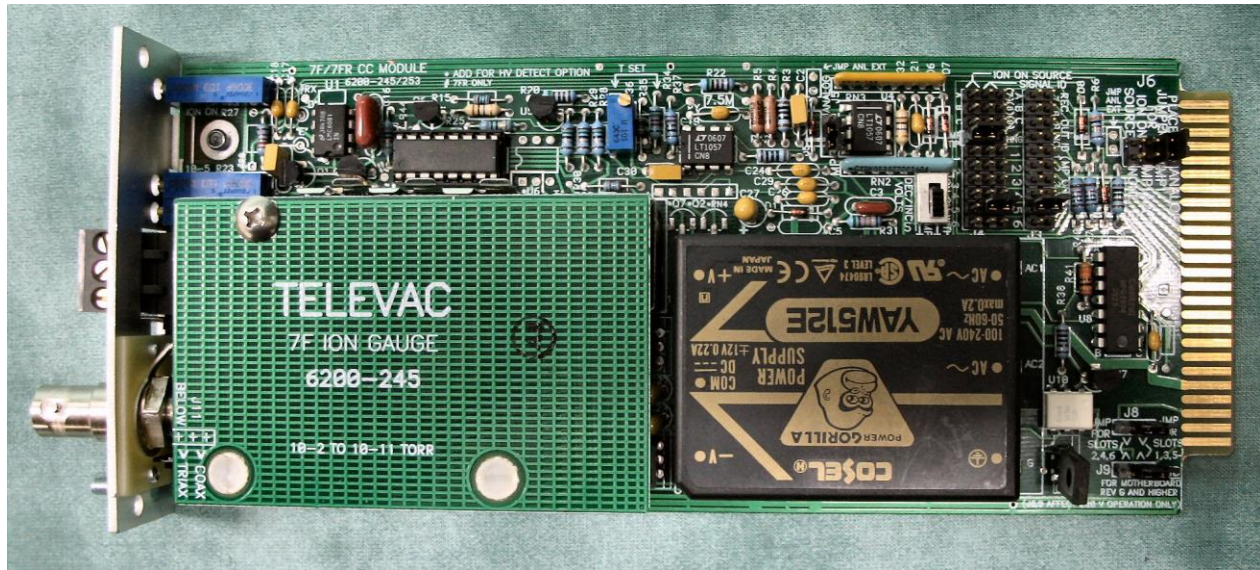

Fig. 9.4b – 7F Cold Cathode Gauge Module

Additional jumpers are required as shown below. Finally, there is a switch, S1, which must be placed in the MP position.

Board #	Type	Jumpers (Factory set)
2-6200-227*	7B2	J1 in 7B MP, J3 in MP
2-6200-223*	7E	J1 in 7E, J3 in MP
2-6200-245 or -285	7F UHVJ5 in MP, J8, J9 as noted	J11 Select for type cable

\* Combined 2-6200-223/227 board





Cold cathode gauges have jumpers on the PC board so that the following selections can be made for control by thermocouple or convection type gauges:

1. Analog
2. MPI
3. MPI#2
4. None

If any cold cathode gauges are installed, the following scheme is employed so that their operation may be controlled by associated thermocouple or convection type gauges:

1. The "Analog" selection would not normally be used with the model MM200. It is included for use when the board is installed in an analog MA200 unit. However, it can also be used in a microprocessor unit if desired. The analog selection allows selection of any other sensor to control the on-off operation of the cold cathode. The controlling station is selected by jumpers on the cold cathode PC board. The jumper that is normally in the "MP" position is moved to make this selection. The set point is manually set using a potentiometer on the cold cathode PC board. The comparison is made between the raw signal (not linearized) from the selected sensor, and the potentiometer setting. The controlling sensor would normally be any thermocouple or convection type sensor. A hot cathode sensor should never be chosen for the controlling sensor.
2. MPI can be selected with the jumper, in which case, the lowest station number thermocouple or convection type gauge controls the on-off operation of the cold cathode gauge.
3. MPI#2 can be selected with the jumper, in which case, the next lowest station number thermocouple or convection type gauge controls the on-off operation of the cold cathode gauge.
4. A cold cathode gauge can ignore this control feature by selecting "None" on the PC jumper.

If MPI is selected, the cold cathode gauge will be shut down when the pressure at the lowest station numbered thermocouple or convection type gauge reaches a particular pressure. In this case, the cold cathode gauge should be assigned to an "odd" station number. The display will then show "OFF" when it is in shut-down.

Likewise, if MPI#2 is selected, the cold cathode gauge should be assigned an "even" station number.

The pressure at which shut down occurs, when using MPI or MPI#2, depends on the configuration of the MM200. If any 7Es or a 3D or 3E is installed, the pressure will be twenty microns, otherwise, it will be 10 microns.



**DIAPHRAGM MODULES-** Diaphragm modules are shown in Fig. 9.5a and 9.5b. This module is typical of all modules. The assignment of station identification numbers on a diaphragm module is accomplished by placing jumpers across the appropriate pins in the SIGNAL ID and the REC OUT ID sections. The upper diaphragm station has been named station #3 and the lower thermocouple station has been named station #4 as an example. Do not duplicate station # assignments with other modules. Also two (2) jumpers are placed in the "MP" positions of the ANALOG/MP section of the board.

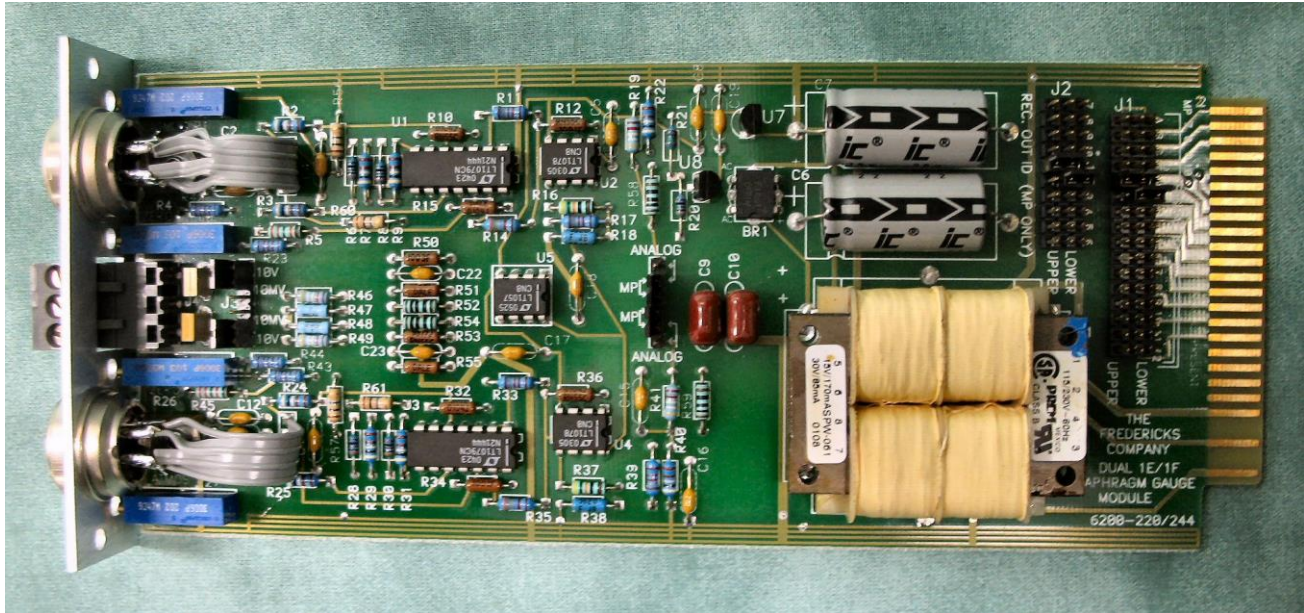

Fig. 9.5a - Diaphragm Module



Finally, there are jumpers placed in the 10V position of J3. This provides a 0 to 10VDC analog "0-10V" output. The alternate is a 0 to 10 mV output. This not recommended unless your recorder cannot handle 10V.

Labels are placed on the rear panel to show the station names assigned.

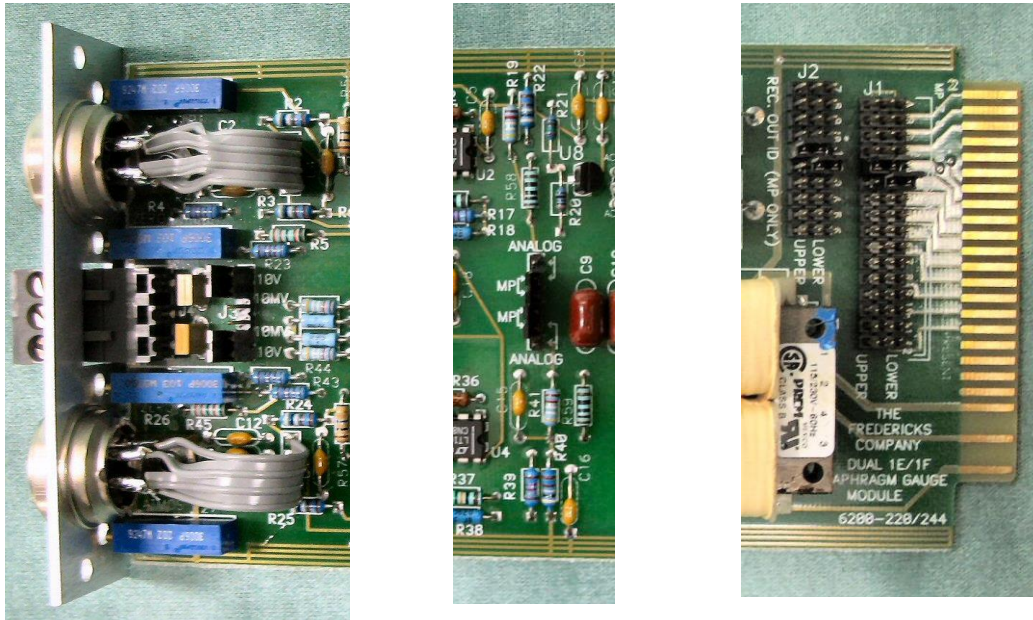

Fig. 9.5b - Diaphragm Module Details





**CAPACITANCE DIAPHRAGM MODULE** - A CDG module is shown in Fig. 9.6a and 9.6b. This module is typical of all modules. The assignment of station identification numbers on a CDG module is accomplished by placing jumpers across the appropriate pins in the SIGNAL ID and the REC OUT ID sections. The upper CDG station has been named station #3 and the lower thermocouple station has been named station #4 as an example. Do not duplicate station # assignments with other modules. Also two (2) jumpers are placed in the "MP" positions of the ANALOG/MP section of the board.



Fig. 9.6a - Capacitance Diaphragm Module

**NOTE:**

Capacitance Diaphragm Gauge Tubes with a range of greater than 1 Torr will **not** control the Cold Cathode automatic turn on!





Finally, there are jumpers placed in the 10V position of J3. This provides a 0 to 10VDC analog “0-10V” output. The alternate is a 0 to 10 mV output. This not recommended unless your recorder cannot handle 10V.

Labels are placed on the rear panel to show the station names assigned.



Fig. 9.6b - Capacitance Diaphragm Module Details



3D HOT CATHODE MODULE

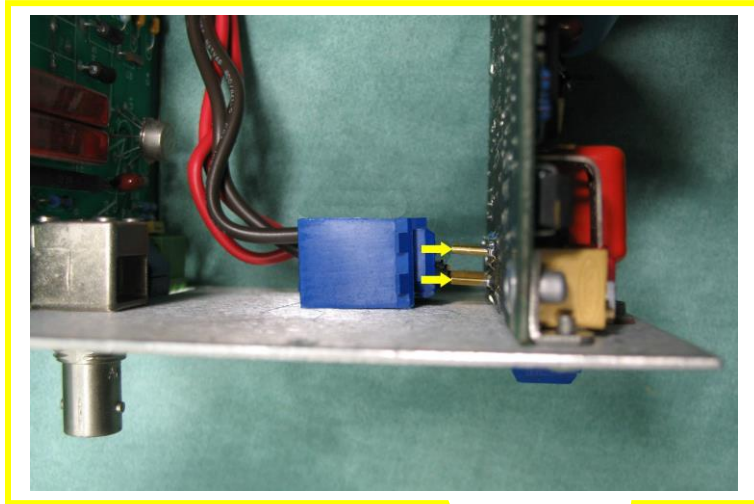

WHEN MATING J1A CONNECTOR V-  
GROVE TOWARD THE TRANSFORMER  
FLAT SURFACE TOWARD THE BACK  
PANEL

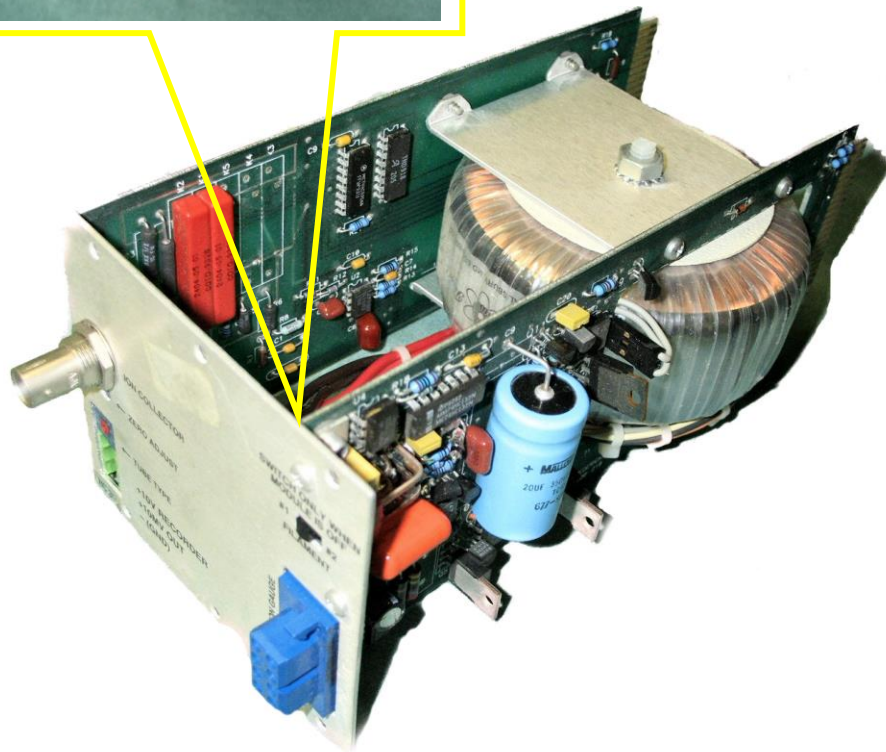
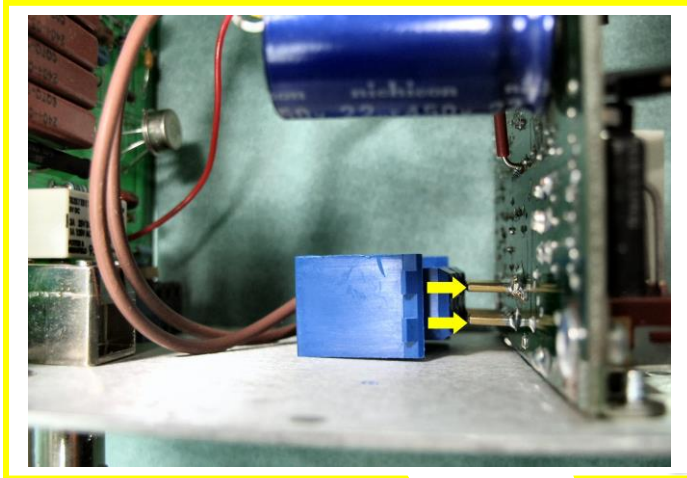

Fig. 9.7a - 3D Hot Cathode Module Details



3E HOT CATHODE MODULE



WHEN MATING J1A CONNECTOR V-  
GROVE TOWARD THE TRANSFORMER  
FLAT SURFACE TOWARD THE BACK  
PANEL

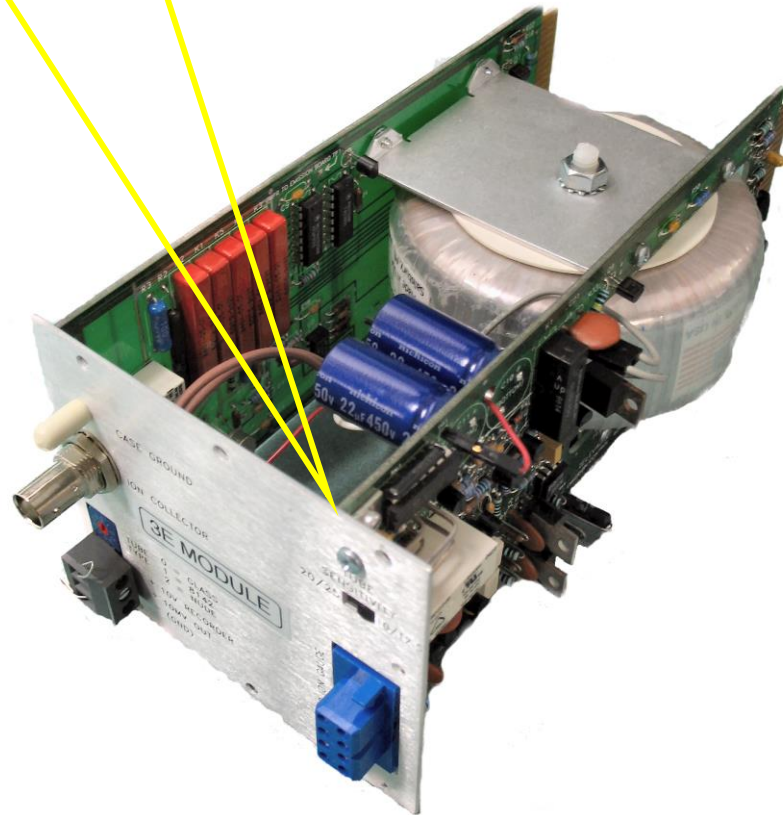
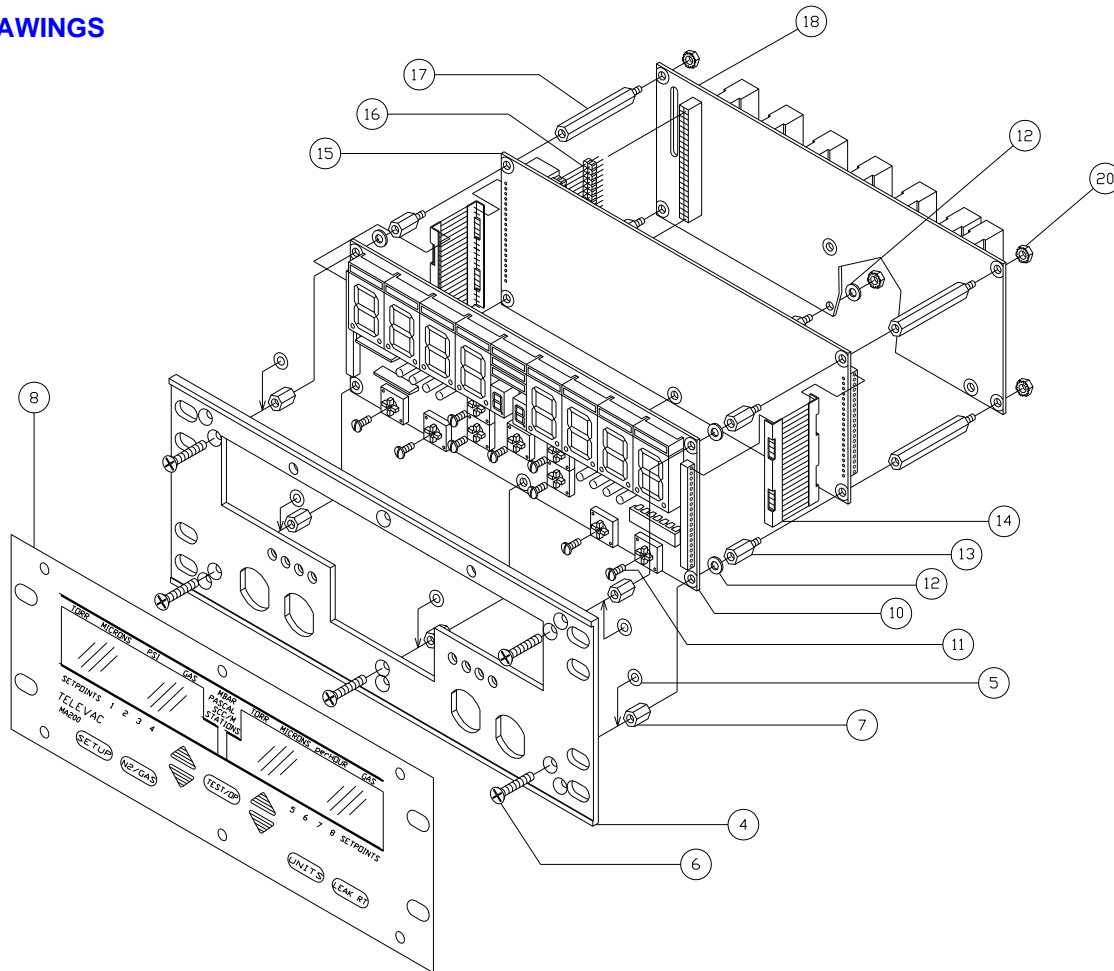

Fig. 9.7b - 3E Hot Cathode Module Details





903 DRAWINGS



20	5	#6-32 KEPS NUT	4210-83	
-	-	-	-	
18	1	MOTHER BOARD PCB ASSY	6200-185	PCB 3900-80
17	5	#6, 1.5LG M/F HEX SPACER	4210-145	HHS8258
16	1	XTNDR BERG-STICK DBL 2x22	5500-63	SAMZW221960830-250
15	1	LOGIC BOARD PCB ASSY	6200-195	PCB 3900-92
14	2	RIBBON CONN.	8400-27	T&B FHN .85M20
13	5	#6, 3/8"LG M/F HEX SPACER	4210-144	HHS8249
12	6	#6, 1/16"THK FIBRE WASHER	4210-128	DIGIKEY #3370K
11	9	#4-40,3/16"LG PANHD SLOT SC	4210-148	FOR PUSH BUTTON SW.
10	1	DISPLAY BOARD PCB	6200-196	PCB 3900-93
-	-	-	-	
-	-	-	-	
8	1	OVERLAY	7600-41	
7	5	#6, 1/4"LG F/F HEX SPACER	4210-143	HHS2320
6	5	#6-32, 11/16"LG. FLHD. SC	4210-132	
5	5	WASHER, INTERNAL STAR, #6, BLACK	6-4210-82	
4	1	FRONT PANEL	5300-144	



## 904 CLEANING COLD CATHODE GAUGE TUBES

Any cleaning schedule is dependent on cycle time/frequency and the degree of contaminants present in the manufacturing process. Each facility should determine a schedule based on their own specific experience. When it is established, the following cleaning procedure is recommended:

1. Remove the sensor from the vacuum chamber.
2. Unscrew the cap to expose the anode assembly (to remove, rotate cap counter clockwise).
3. Gently lift the anode assembly upwards to separate it from the body.
4. Remove the “o” ring from the body, being careful not to scratch the “o” ring seat. Wipe it off with a lint free tissue making sure that it is still intact (no cracks or tears). It should be round and not flattened out.
5. Blast the entire anode assembly at 30 psi using glass beads, being careful not to damage the glass feedthrough. (If any rainbow effect is noticed, a possible crack in the feedthrough may exist and the anode assembly may need to be replaced. P/N2-6200-37).
6. Blast the body with glass beads concentrating on the pole piece and the “o” ring areas. Clean the remaining internal parts. If the threaded end of the tube needs cleaning, it can be glass blasted as well.
7. After cleaning, blow out any residual glass beads or dust with dry air. See that all metal particles are removed from the pole piece areas.
8. Re-grease the “o” ring with Apiezon L or M grease, (a vacuum approved grease). **DO NOT APPLY EXCESS GREASE.** “o” ring should be shiny.
9. Install “o” ring in body.
10. Replace the anode assembly in the body after the “o” ring has been installed. Observe the keyway location.
11. Screw the cap on and hand tighten.
12. Reinstall in the vacuum chamber.
13. after the seal on threads has cured, allow 1 – 2 hours for the tube to degas when pumped down to high vacuum.



905 SUPPRESSOR INSTALLATION FOR NOISY ENVIROMENTS

For noisy environments, add suppressor to cable as shown. One suppressor is required for each cable.

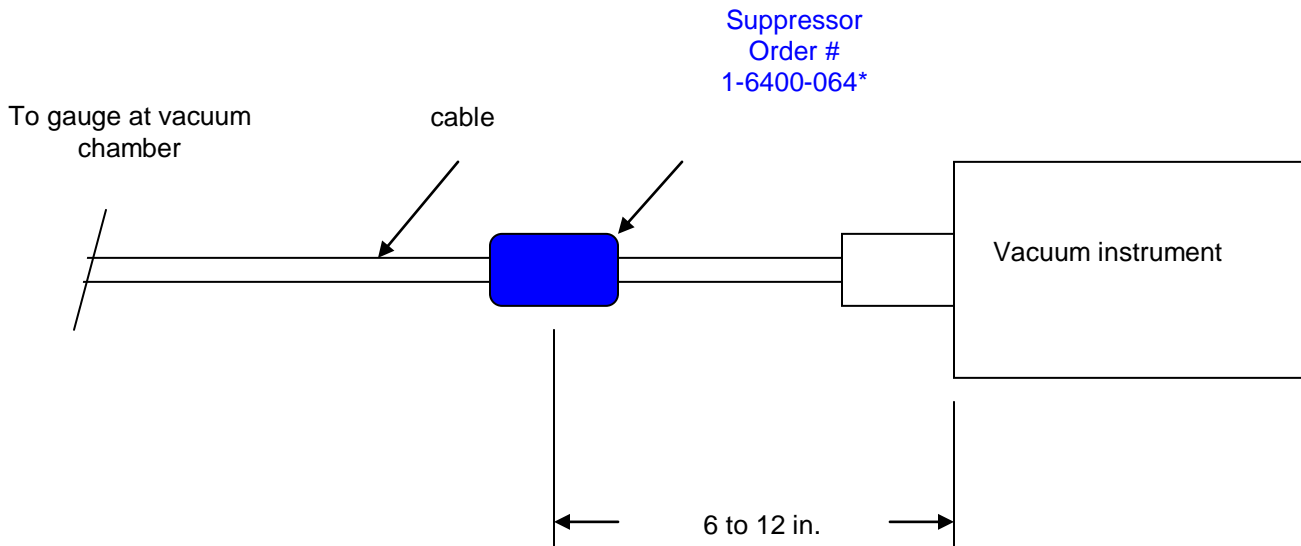

\* 3D & 3E module only use 1-6400-063



1000 MISCELLANEOUS

**CALIBRATION MODE** In some instances units will be set up in the factory or at the customer's facility via RS232 to be in the CALIBRATION MODE. In this case additional resolution is available on the display. In some instances the resolution will be greater than the accuracy of the sensor in some pressure ranges. When the unit is first turned on, the display will read CAL 1.XX, if it is in the CALIBRATION MODE (e.g., CAL 1.29). Otherwise it will read SOFT 1.XX.

**DIAPHRAGM GAUGES** The accuracy of the 1E and the 1F diaphragm gauges relies on setting the calibration at both the "zero" point and at full scale for the sensor used. When calibrated at "zero", using the "ZERO" potentiometer, the reference pressure must be two decades or more below the lowest reading - 1E: 0.01 Torr or lower; 1F: 10 Torr or lower. The upper setting is made using the "ATM" or "SPAN" potentiometer when the reference pressure is - 1E: Atmospheric pressure (760 Torr or 1010 mbar); 1F: 10,000 mbar.

Accuracy is shown below in % of full-scale reading when calibrated at ZERO and full scale:

Error in  
 Percent of  
 Full Scale

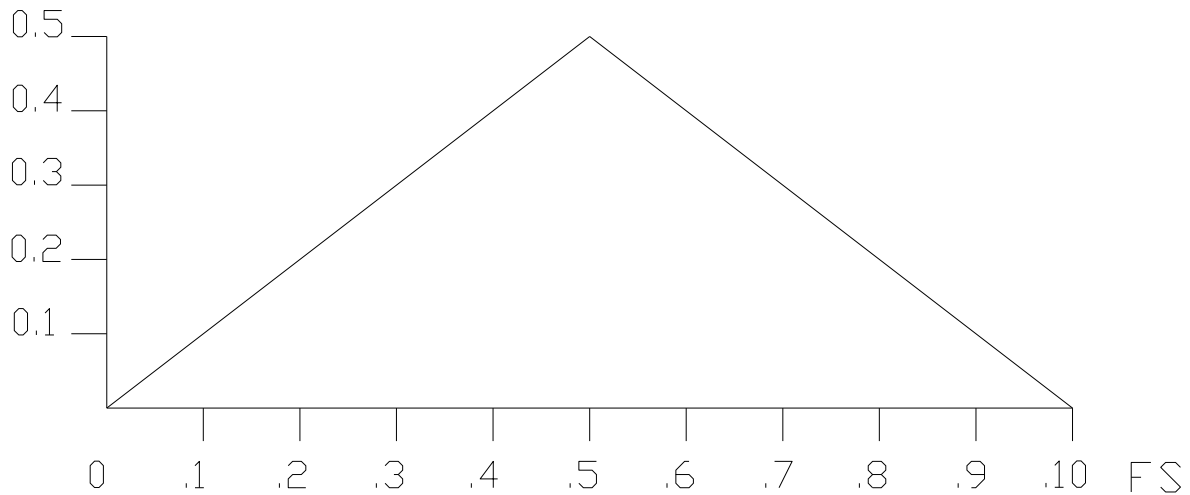



## INSTALLATION OF EPROMS

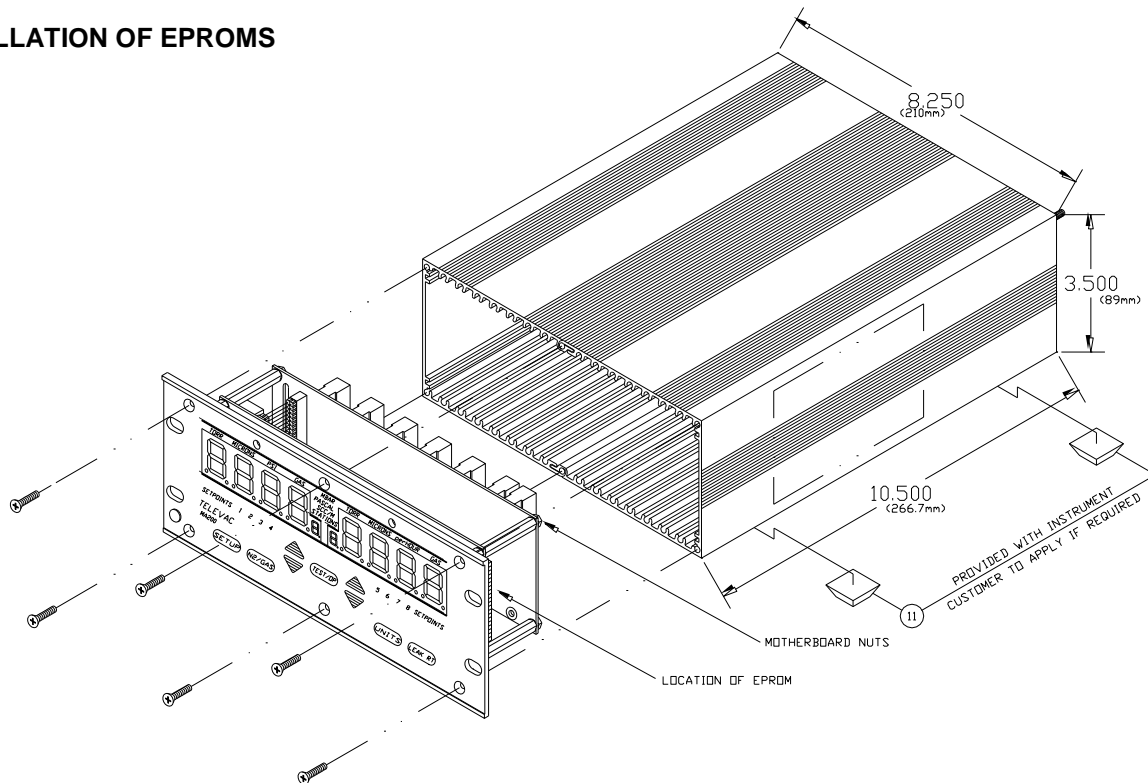

1. WORK IN A STATIC FREE WORK AREA AND USE GROUNDING STRAPS.
2. REMOVE (3) SCREWS #4 AND (3) SCREWS #5 FROM FRONT PANEL
3. PRY FRONT PANEL ASSEMBLY LOOSE AND PULL OUT
4. LOCATE EXISTING EPROM ON LOGIC BOARD
5. REMOVE MOTHERBOARD, ONLY IF REQUIRED, TO GET ACCESS TO EPROM
6. REMOVE EPROM. NOTE ORIENTATION OF KEYWAY (TOWARD OUTSIDE OF PCB).
7. INSERT NEW EPROM BEING CAREFUL THAT ALL PINS ARE ALLIGNED WITH THE SOCKET AND THE KEYWAY FACES OUTWARD.
8. REASSEMBLE